

ULTRA[®]
ARIOSTEA[®]HIGHTECH

320 × 160

300 × 150

300 × 100

ULTRA®

ARIOSTEA® HIGHTECH

4	+	Introduction
6	+	Ultra Sizes
8	+	Ultra Collections
10	+	Thickness
12	+	Finishes
14	+	Applications
24	+	Ventilated Façades
26	+	Back Light
30	+	Ultra Marmi Collection
88	+	Ultra Onici Collection
102	+	Ultra Metal Collection
120	+	Ultra Iridium Collection
124	+	Ultra iCementi Collection
136	+	Ultra Pietre Collection
164	+	Ultra Resine Collection
178	+	Metro Collections
180	+	Ultra Wood Collection
206	+	Ultra Technology
239	+	Technical features
242	+	Codes and Sizes
244	+	Tailor-made packaging
254	+	Ariostea Greenroom



4

Ci sono momenti tecnologici in cui un prodotto segna il passo allo stato della tecnica modificando il nostro stile di vita. È stato così con l'avvento dell'automobile, della televisione, di internet o degli smartphone per esempio. Crediamo che ragionevolmente ed egualmente si possa guardare, con simile ammirazione, al salto tecnologico che ha consentito al settore ceramico di passare dai formati tradizionali a quelli giganti che contraddistinguono il progetto Ultra. La scala di grandezza dei materiali supera ora ampiamente i riferimenti antropometrici del Modulor teorizzato da Le Corbusier nel 1948, toccando i 3 metri di altezza e rapportandosi non più solo al fattore umano ma all'edificio nel suo complesso, consentendone la risoluzione dell'interfaccia esterna oltre alla vestizione degli spazi interni.

There are technological moments in which a product makes the leap to being state of the art and changes our life style. For example, it was so for the automobile, the television, the Internet and smartphones. We feel that you could reasonably and equally look, with similar admiration, to the technological leap that has allowed the ceramic sector to move on from its traditional sizes to giant ones, like those that distinguish the Ultra project. The scale of proportions is now far larger than the anthropometric reference points of the Modulor originally theorized by Le Corbusier in 1948. These reach 3 metres in height and relate not only to just the human factor, but to the building in its entirety allowing the resolution of the external interface as well as the dressing of the internal spaces.



ULTRA[®]

ARIOSTEA[®]HIGHTECH

Es gibt Momente, in denen ein Produkt der modernen Technik weicht und so unseren Lebensstil verändert.

Dies war ganz eklatant der Fall, als das Automobil, der Fernseher, Internet oder die modernen Smartphones erfunden wurden.

Wir sind der Meinung, dass man auf gleiche Weise und mit fast ähnlicher Bewunderung den technischen Fortschritt betrachten kann, der es der Keramikindustrie ermöglicht hat, von den traditionellen Größen zu den gigantischen und großformatigen Platten zu wechseln, die unser Projekt Ultra auszeichnen. Die Größenordnung des Materials überragt bei Weitem das anthropometrische Proportions-System des von Le Corbusier im Jahr 1948 theoretisierten Modulors und passt sich mit seinen 3 Metern Höhe nicht nur dem Faktor Mensch an, sondern auch dem gesamten Gebäudekomplex, wodurch eine Auflösung der externen Schnittstelle ermöglicht wird, die weit über die einfache Verkleidung des Innenraums hinausgeht.

Il existe des moments technologiques où le produit marque le pas sur l'état de la technique, en modifiant notre style de vie.

C'est ce qui est arrivé avec l'avènement de l'automobile, de la télévision, d'Internet ou des smartphones, par exemple.

Nous pensons qu'il est possible d'étudier de manière raisonnable et égale, mais aussi avec une admiration semblable, les progrès technologiques qui ont permis au secteur de la céramique de passer des formats traditionnels aux formats immenses qui distinguent le projet Ultra. L'échelle de grandeur des matériaux dépasse désormais largement les références anthropométriques du Modulor théorisé par Le Corbusier en 1948, atteignant 3 mètres de hauteur et se rapportant non plus seulement au facteur humain, mais au bâtiment dans son intégralité, permettant la résolution de l'interface externe, ainsi que l'habillage des espaces internes.

6_{mm} THICKNESS

10_{mm} THICKNESS

8 COLLECTIONS

4 FINISHES

ULTRA[®]

ARIOSTEA[®]HIGHTECH

320 X 160

300 X 150

300 X 100

BIGGEST

ULTRA con i suoi 5,12 m² è il nuovo punto di riferimento per i progettisti e per tutti gli interventi dove le dimensioni fanno la differenza.

With its area of 5,12 m², ULTRA is the new industry standard for project designers and for all projects where dimensions make the difference.

Mit seinen 5,12 m² ist ULTRA die neue Bezugsgröße für die Gestalter und für alle Gelegenheiten, bei denen die Maße den Unterschied bilden.

ULTRA et ses 5,12 m² est un nouveau point de référence pour les concepteurs et dans toutes les interventions où les dimensions font la différence.

LIGHTEST

ULTRA con il suo spessore 6 mm nativo, garantisce leggerezza e resistenza per tutte le applicazioni, anche quelle a cui non avevi pensato.

Thanks to its native 6 mm thickness, ULTRA provides lightness and strength in all applications - even the ones you'd never even imagined.

Mit seiner ursprünglichen Dicke von 6 mm garantiert ULTRA leichtes Gewicht und Widerstandsfähigkeit für alle Anwendungen, auch solchen, an die Sie vielleicht nicht gedacht haben.

ULTRA, aux épaisseurs de 6 mm à l'état natif, est un gage de légèreté et de résistance pour toutes les applications, même celles auxquelles vous n'aviez pas pensé.

TAILORED

ULTRA offre estrema flessibilità al progetto e la libertà di realizzare le tue idee senza vincoli di formato.

ULTRA offers unmatched project flexibility and the freedom to give concrete form to your ideas without being shackled by size.

ULTRA bietet höchste Flexibilität der Gestaltung und die Freiheit, Ideen zu entwickeln, ohne durch das Format eingeschränkt zu sein.

ULTRA offre une grande polyvalence dans la création de projet ainsi que la liberté de réaliser vos idées sans contraintes de format.

320x160
128"x64"

300x150
120"x60"

150x150
60"x60"

150x100
60"x40"

150x75
60"x30"

75x75
30"x30"

75x37,5
30"x15"

300x100
120"x40"

100x100
40"x40"

180x21,5
72"x8 1/2"

ULTRA®

ARIOSFEA HIGHTECH

320X160
300X150

320X160

10 mm
THICKNESS

6 mm
THICKNESS

FORMATO DISPONIBILE SU RICHIESTA / SIZE AVAILABLE UPON REQUEST
FORMAT AUF ANFRAGE ERHÄLTICH / FORMAT DISPONIBLE SUR DEMANDE

SPESORE DISPONIBILE SU RICHIESTA / THICKNESS AVAILABLE UPON REQUEST
STÄRKE AUF ANFRAGE ERHÄLTICH / ÉPAISSEUR DISPONIBLES SUR DEMANDE

DISPONIBILE PER TUTTI I MATERIALI E TUTTI I FORMATI / AVAILABLE FOR ALL
MATERIALS AND ALL SIZES / ERHÄLTICH FÜR ALLE MATERIALIEN UND IN ALLEN
GRÖßENFORMATEN / DISPONIBLE POUR TOUS LES MATÉRIAUX ET TOUS LES FORMATS.

ULTRA MARMI
soft/shiny

ERAMOSABROWN

TRAVERTINO SANTA CATERINA

CREMA MARFIL

TRAVERTINO NAVONA

ESTREMOZ

PAGNAZZETTO S

BIANCO COVELANO

THASSOS

STATUARIO ULTRA

ULTRA ONICI
soft/shiny

ONICE BEIGE

ONICE BIANCO EXTRA

ONICE GRIGIO

ULTRA iCementi
soft

BRONZE

SILVER

IVORY

IRON

GRAPHITE

ULTRA METAL
soft

BROWN ZINC

GREY ZINC

BLUE ZINC

ULTRA WOOD
soft

NOCE AMERICANO

NOCE CHIARO

NOCE CALCE

NOCE OSSIDATO

NOCE SCURO

ULTRA WOOD 180x21,5 cm

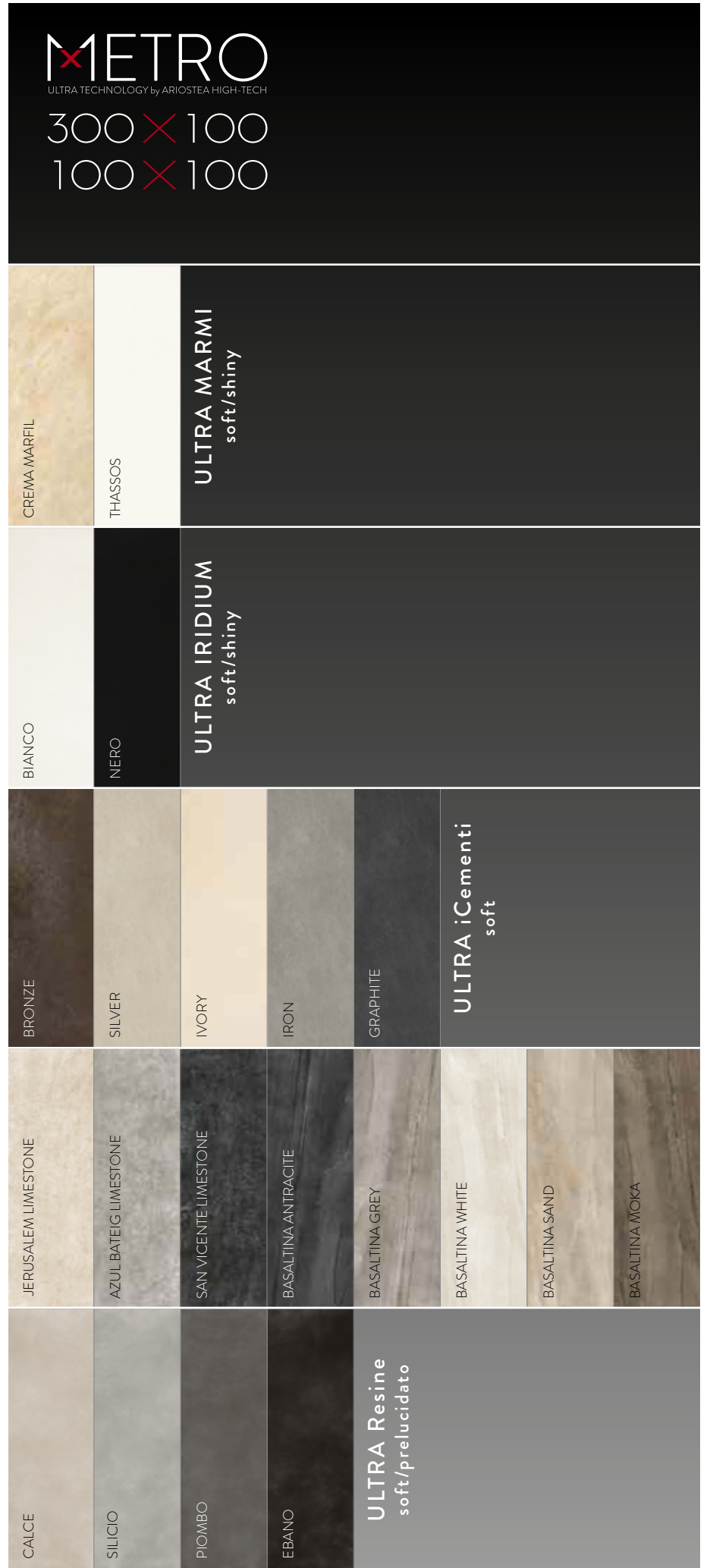
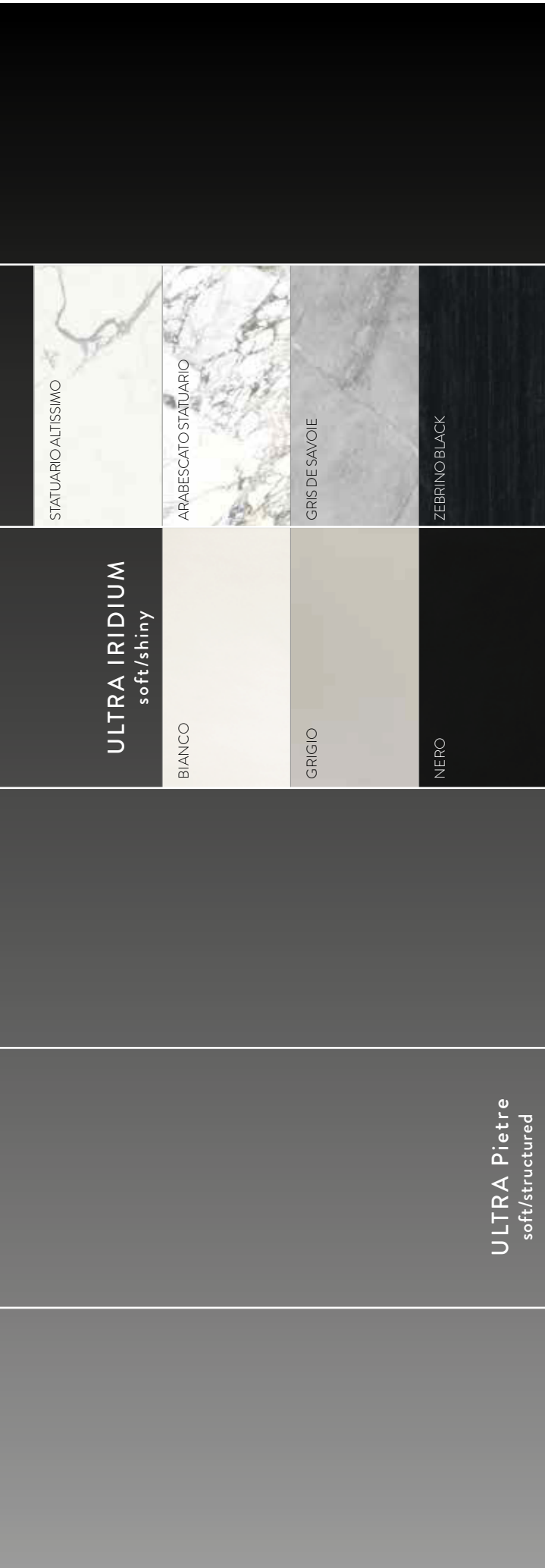

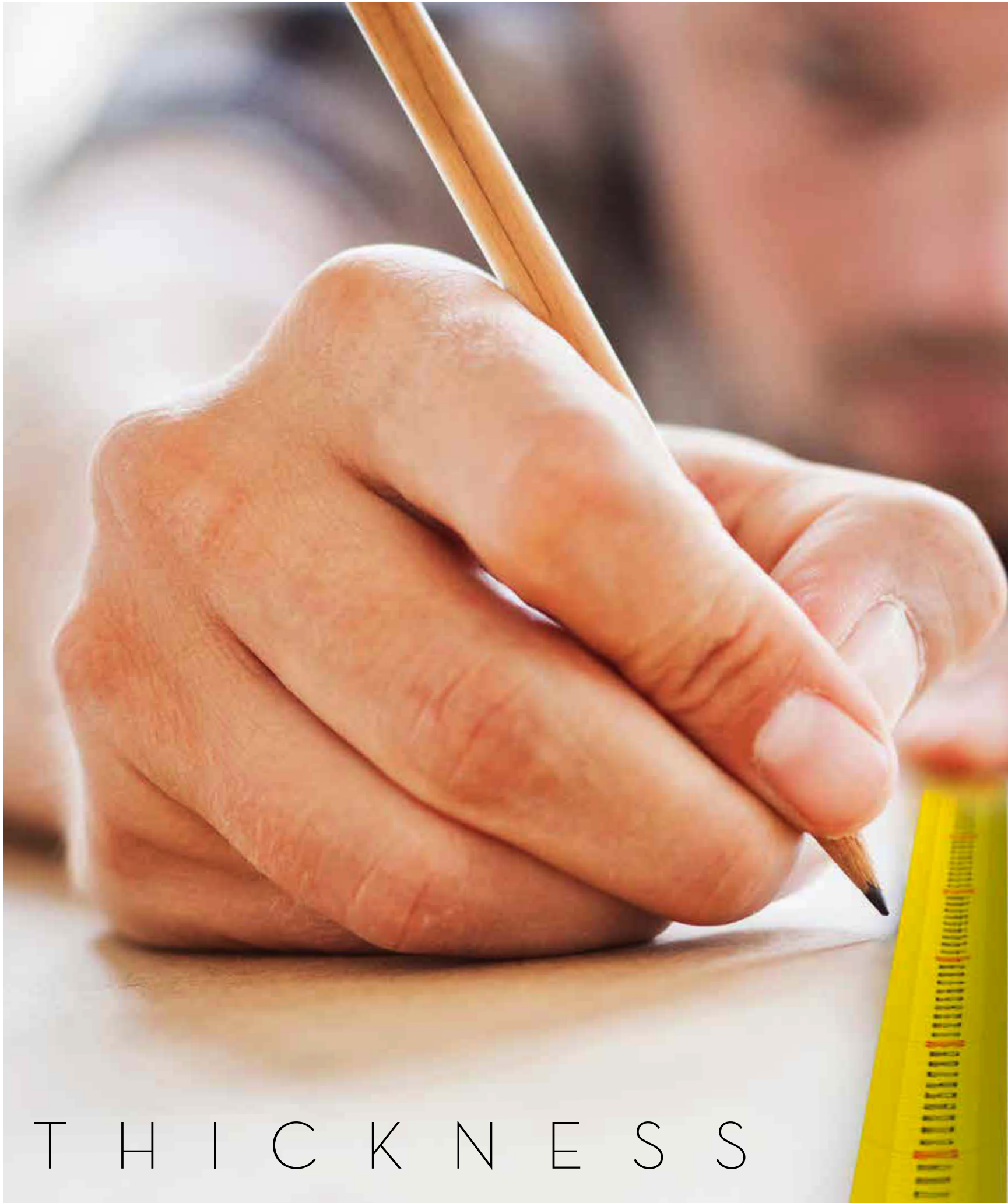

T H I C K N E S S

6/10mm

Per rendere la tecnologia Ultra sempre più flessibile e adattabile alle diverse esigenze applicative, tutte le collezioni basate sui formati nativi 320 x 160, 300 x 150, 300 x 100 cm sono disponibili con spessore 6 mm e a richiesta 10 mm.

To make Ultra technology more and more flexible and adaptable to different application needs, all the collections based on the native sizes of 320 x 160, 300 x 150, 300 x 100 cm are available with a thickness of 6 mm and on request also 10 mm.

Um die Ultra-Technologie stets flexibler gestalten und besser an die unterschiedlichsten Verwendungszwecke anpassen zu können, sind alle Produkte aus der Kollektion in den standardmäßigen Größenformaten 320 x 160, 300 x 150, 300 x 100 cm erhältlich, die mit einer Stärke von 6 mm und auf Wunsch 10 mm erhältlich sind.

Pour rendre la technologie Ultra de plus en plus flexible et adaptable aux besoins des différentes applications, toutes les collections basées sur des formats traditionnels 320 x 160, 300 x 150, 300 x 100 cm sont disponibles avec une épaisseur 6 mm et sur demande 10 mm.



F I N I S H E S



SHINY



SOFT



STRUCTURED



PRELUCIDATO

APPLICATION DESIGN



The flexibility of ULTRA technology allows the various product collections developed by Ariostea to be completely adapted to generate projects ranging from simple flooring or coverings for large or small surfaces to object-based applications and furnishing accessories.

Using this new concept that combines light weight and technical performance, it is now possible to create genuine products or installations with the added benefits that come with ceramic technology. The very nature of the material also lets designers apply each of these possibilities in indoor and outdoor environments to develop smooth, curved and even backlit surfaces.

La duttilità della tecnologia ULTRA consente di adattare le varie collezioni di prodotti sviluppate da Ariostea generando progetti che spaziano dal semplice pavimento o rivestimento di piccole e grandi superfici, all'applicazione su oggetti e complementi d'arredo.

Realizzare veri e propri manufatti o installazioni con un nuovo concetto di leggerezza e prestazione tecnica coniugata è ora possibile avendo accesso anche alle prestazioni superiori date dalla tecnologia ceramica. La natura stessa del materiale consente inoltre al progettista di declinare ognuna di queste possibilità in ambienti interni ed esterni sviluppando superfici omogenee, curve e anche retroilluminate.

APPLICATIONS DESIGN
**TOPS &
KITCHEN**



16



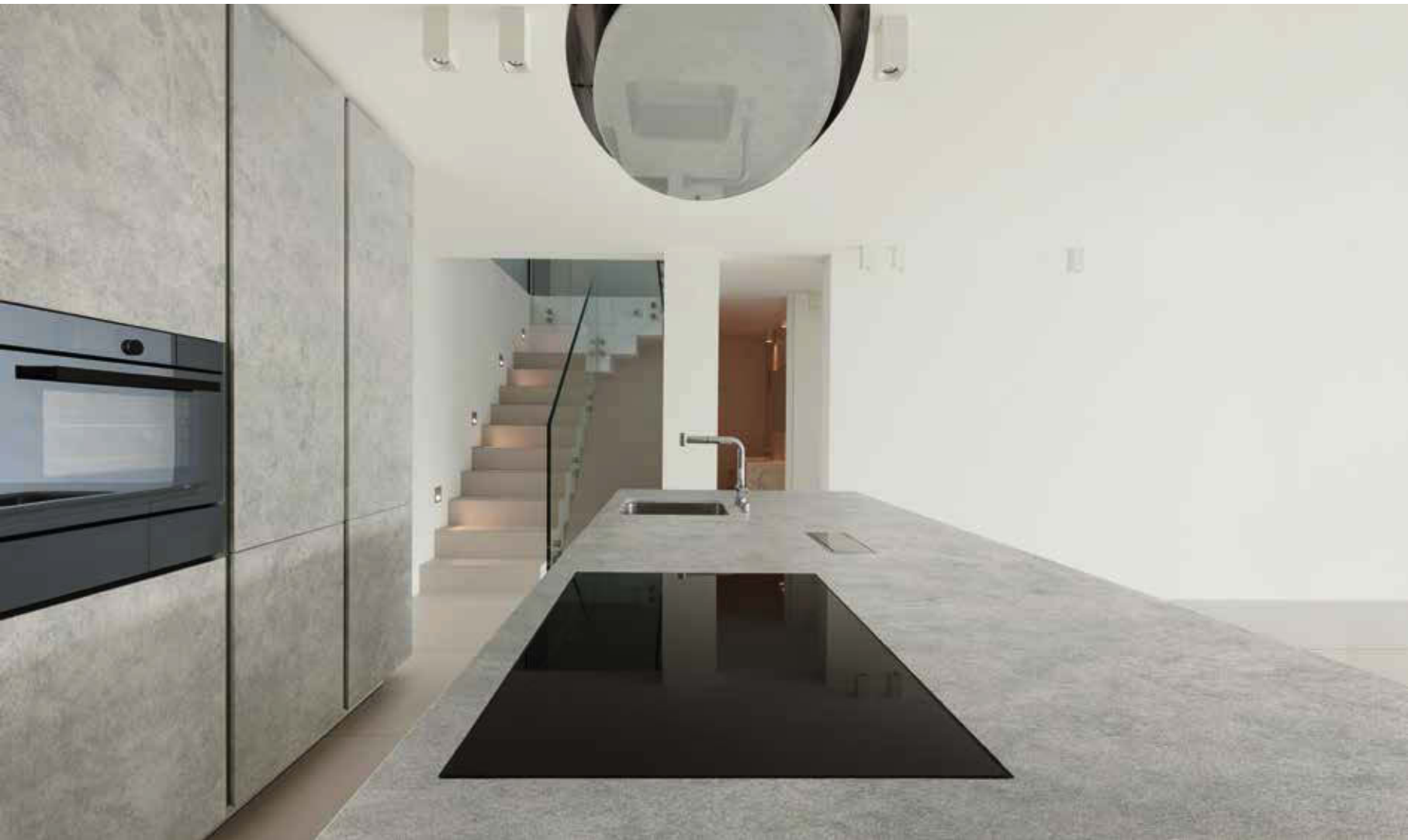

APPLICATIONS DESIGN
TOPS &
BATHROOMS





19



APPLICATIONS DESIGN
FLOORS &
WALLS

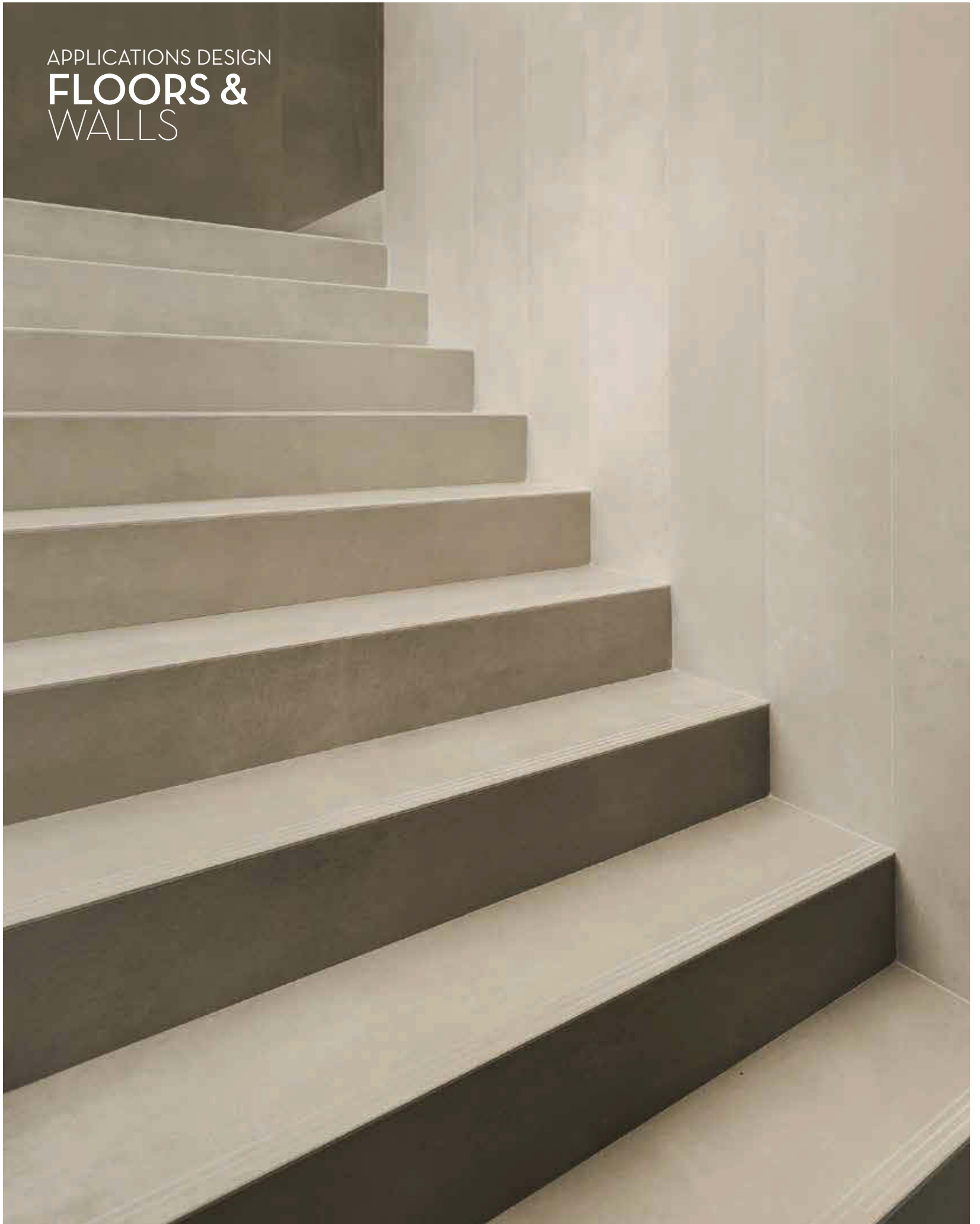

APPLICATIONS DESIGN
CURVED
WALLS



APPLICATIONS DESIGN
DOORS &
SLIDING
WALLS





APPLICATIONS DESIGN
INTERIOR
DECORATION
& DESIGN

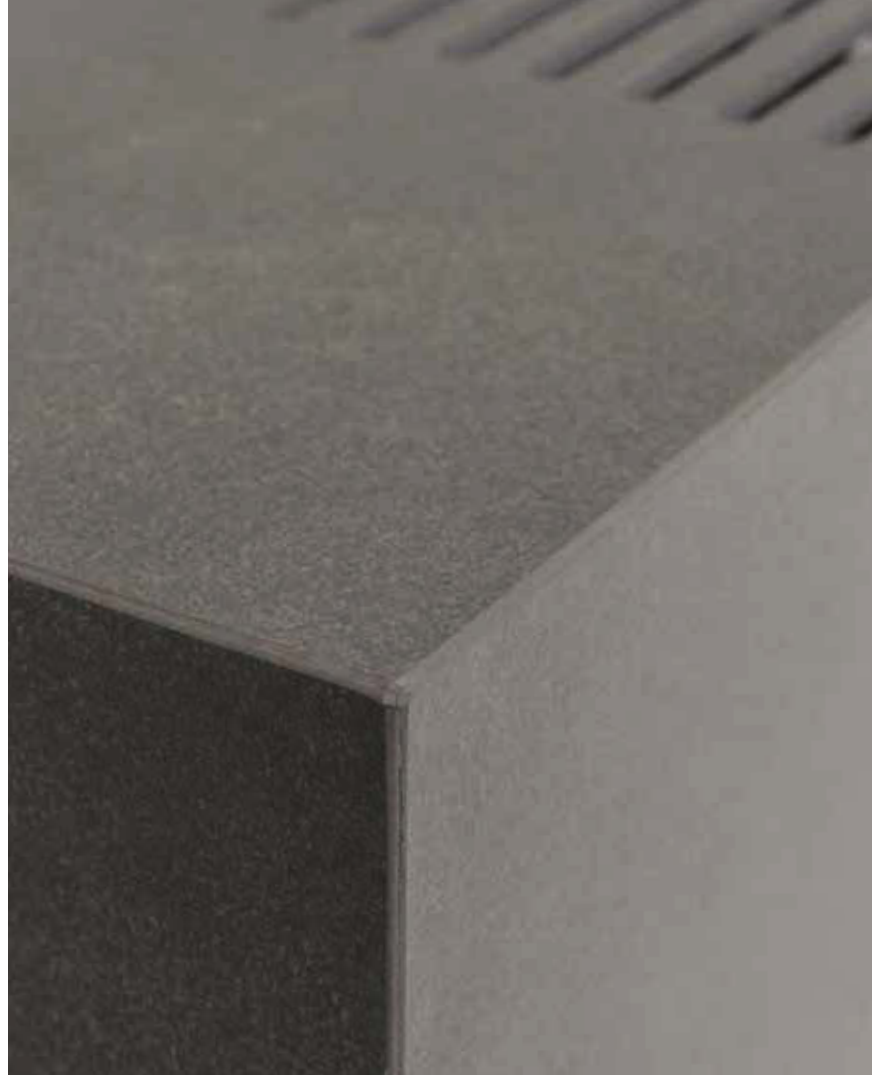



VENTILATED FAÇADE

SAFETY CLIP SYSTEM
WET ENVELOPES

SISTEMA SAFETY CLIP
INVOLUCRO A UMIDO



THERMAL CLADDING SYSTEM
WET ENVELOPES

SISTEMA A CAPPOTTO
INVOLUCRO A UMIDO



MICRO SYSTEM
DRY ENVELOPES

SISTEMA MICRO
INVOLUCRO A SECCO



VENTILATED FAÇADE
DRY ENVELOPES

FACCIATA VENTILATA
INVOLUCRO A SECCO



ULTRA FRAME SYSTEM
DRY ENVELOPES

SISTEMA ULTRA FRAME
INVOLUCRO A SECCO



ULTRA LIGHT SYSTEM
DRY ENVELOPES

SISTEMA ULTRA LIGHT
INVOLUCRO A SECCO



BACKLIGHT

26





The extremely reduced 6mm thickness, together with the advanced Ultra technology, allows an appropriately powerful band of light to travel through the Ultra slabs and backlight the material.

Lo spessore estremamente contenuto di 6 mm insieme all'evoluta tecnologia consentono ad alcuni prodotti Ultra di poter essere attraversate da un fascio luminoso di adeguata potenza ottenendo la retroilluminazione del materiale.

ULTRA[®]
ARIOSTEA[®]HIGHTECH

ACTIVE[™]
CLEAN AIR & ANTIBACTERIAL CERAMIC

La nuova tecnologia ACTIVE consente di ecoattivare anche le grandi lastre ULTRA by Ariostea High Tech.

Mediante l'uso dell'applicazione digitale vengono migliorate ulteriormente le prestazioni fotocatalitiche delle lastre in termini di maggiore efficienza nella degradazione degli inquinanti dell'aria, degli odori e dell'azione antibatterica.

L'efficienza del processo foto catalitico ottenuto dalla combinazione delle tecnologie ACTIVE e ULTRA consente di ottenere un nuovo materiale ecoattivo per facciate esterne che, in determinate condizioni, crea una superficie autopulente con grande beneficio per l'ambiente esterno e interno degli edifici dove verrà utilizzato.

La nuova tecnologia ACTIVE è basata su un innovativo progetto finanziato dalla Comunità Europea (progetto LIFE ENV/IT/000140).

The new ACTIVE technology also permits organic activation of large ULTRA slabs by Ariostea High Tech.

Through use of the digital application, the photocatalytic performance of the slabs is further improved in terms of greater efficiency in reducing air pollutants, odours and antibacterial action.

The efficiency of the photocatalytic process achieved by combining ACTIVE and ULTRA technologies makes it possible to obtain a new organically active material for exterior facades which, under certain conditions, creates a clean finish with great benefit to the external and internal environment of the buildings for which it will be used.

The new ACTIVE technology is based on an innovative project funded by the European Community (LIFE ENV/IT/000140 project).



M A R M I

Ariosteas vi racconterà attraverso le lastre di Paonazzetto S, Statuario Altissimo, Estremoz e tutte le altre superfici della ricca collezione ULTRA MARMI, la storia di materiali di rara bellezza e grande prestigio famosi per essere stati nell'illustre lavoro dei grandi maestri della scultura e dell'architettura di tutti i tempi.

Through the Paonazzetto S, Statuario Altissimo, Estremoz slabs and all of the other surfaces of the rich ULTRA MARMI collection, Ariosteas will tell you the story of materials of rare beauty and great prestige, famous for being in the illustrious work of the all-time masters of sculpture and architecture.

Ariosteas drückt durch die Platten Paonazzetto S, Statuario Altissimo, Estremoz und alle anderen Oberflächenabdeckungen der vielseitigen Kollektion ULTRA MARMI die geschichtsträchtige, rare Schönheit und das großartige, berühmte Ansehen von Materialien aus, die an die vornehmen Werke der größten Baumeister von Skulpturen und Architekturen aller Zeiten erinnern.

Avec ses dalles Paonazzetto S, Statuario Altissimo, Estremoz et toutes les autres surfaces de la riche collection ULTRA MARMI, Ariosteas vous racontera l'histoire des matériaux d'une beauté rare et prestigieuse, célèbres pour avoir été utilisés dans le travail illustre des grands maîtres de la sculpture et de l'architecture de tous les temps.

6/10_{mm} THICKNESS
13 COLORS
2 FINISHES

300
x150

Disponibile per tutti i materiali.
Available for all materials.
Erhältlich für alle Materialien.
Disponibile pour tous les matériaux.

320
x160

È un formato a richiesta per tutti i materiali.
Size on request for all materials.
Dieses Format kann auf Wunsch für alle Materialien angefordert werden.
Il s'agit d'un format sur demande pour tous les matériaux.

6 mm
THICKNESS

Disponibile per tutti i materiali e tutti formati.
Available for all materials and all sizes.
Erhältlich für alle Materialien und in allen Größenformaten.
Disponibile pour tous les matériaux et tous les formats.

10 mm
THICKNESS

Disponibile a richiesta per tutti materiali.
Available on request for all materials.
Auf Anfrage für alle Materialien erhältlich.
Disponibile sur demande pour tous les matériaux.





Wall: Arabescato Statuario Shiny, 300 x 150 cm

Floor: Noce Scuro Soft, 180 x 21,5 cm



ULTRA MARMI

ARABESCATO STATUUARIO

ULTRA MARMI
ARABESCATO STATUARIO
BOOK
MATCH





35



Wall: Arabescato Statuario Shiny, 300 x 150 cm

Floor: Noce Scuro Soft, 180 x 21,5 cm



PAONAZZETTO S

Una tradizione millenaria racchiusa nelle venature di un marmo bianco puro, unico al mondo per le sue tonalità chiare e le sue sfumature color viola. Utilizzato nell'antichità per le opere più preziose, oggi si rispecchia nelle grandi e sottili lastre ULTRA capaci di dare forma all'autentico splendore del fare architettura.

A thousand-year-old tradition, wrapped up in the veining of our pure white marble, unique all over the world for its clear hues and shades of dark purple. Used in some of the most prized works of antiquity, our large, thin ULTRA slabs today reflect the ability to give shape to the true splendour of making architecture.

Eine jahrtausendalte Tradition, eingeschlossen in den Maserungen eines reinweissen Marmors, einzigartig auf der Welt aufgrund seiner hellen Farbtöne und violetten Schattierungen. In der Antike wurde er für kostbare Werke verwendet – heute spiegelt er sich in den grossen und dünnen Platten ULTRA wieder, welche den puren Glanz der Architektur in Form zu bringen vermögen.

Une tradition millénaire contenue dans les veines d'un marbre blanc pur, unique au monde pour ses tonalités claires et ses nuances violettes. Utilisé dans l'Antiquité pour les œuvres les plus prestigieuses, il se reflète aujourd'hui dans les dalles ULTRA, grandes et fines, capables de donner forme à la splendeur authentique de la réalisation de l'architecture.





FLOOR & WALL
OFFICE
RESTAURANTS
PUBLIC AREAS
OPEN **SPACE**
DINING
RETAIL
HOTELS



Floor and wall: Paonazetto S Shiny, 300 x 150 cm



Floor and walls: Bianco Covelano Shiny, 300 x 150 cm

ULTRA MARMI

BIANCO
COVELANO



ULTRA MARMI
BIANCO COVELANO
MARBLE GRAIN
CONTINUITY









Floor and walls: Bianco Covelano Shiny, 300 x 150 cm

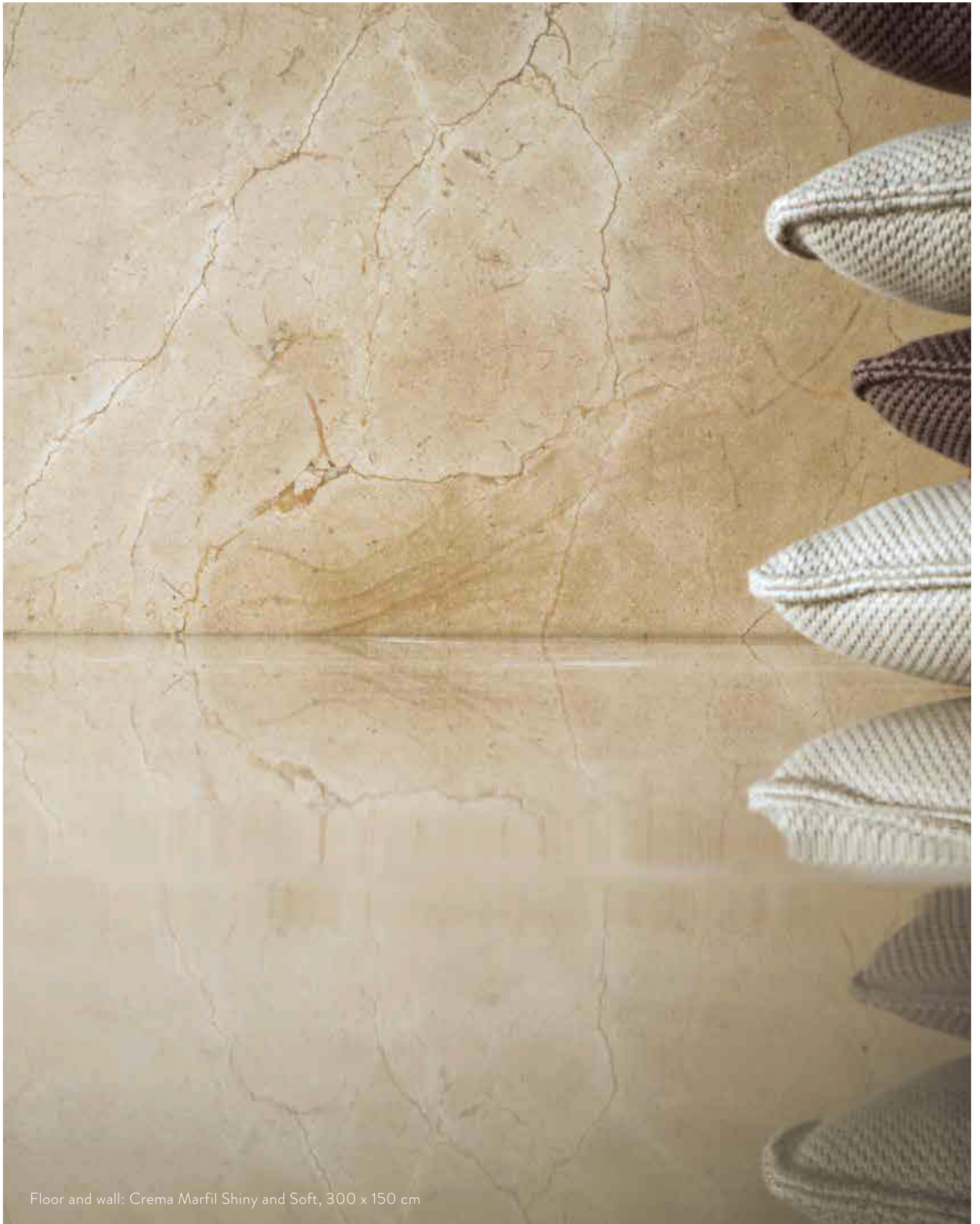

Floor and wall: Crema Marfil Shiny and Soft, 300 x 150 cm

ULTRA MARMI

CREMA MARFIL





Floor, wall and ceiling: Crema Marfil Shiny and Soft, 300 x 150 cm





Floor and wall: Gris De Savoie Shiny, 300 x 150 cm

ULTRA MARMI

GRIS DE SAVOIE





Floor and wall: Gris De Savoie Shiny, 300 x 150 cm

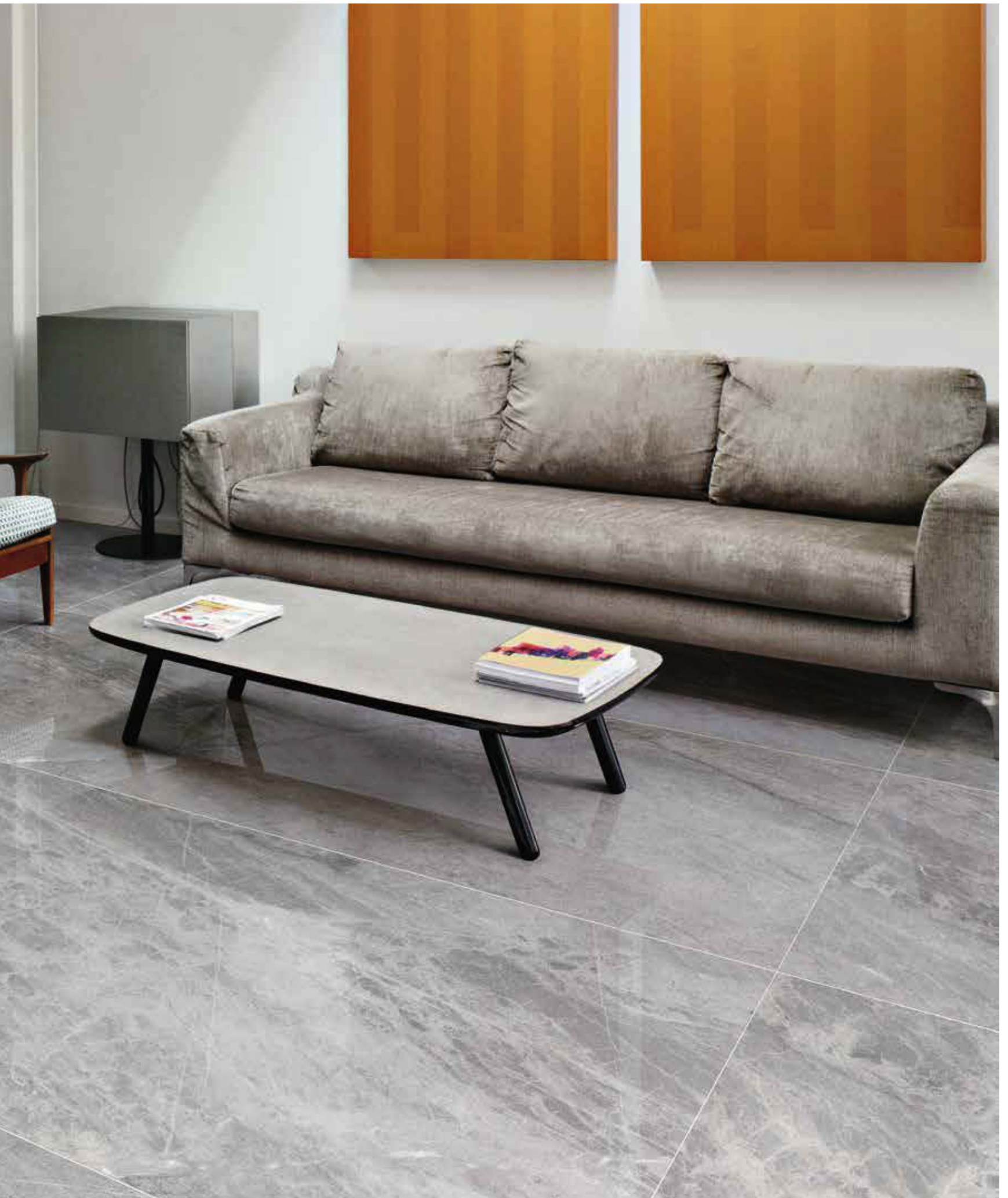



Floor, walls and ceiling: Travertino Navona Shiny, 300 x 150 cm

ULTRA MARMI

TRAVERTINO NAVONA





Floor and wall: Travertino Navona Shiny, 300 x 150 cm

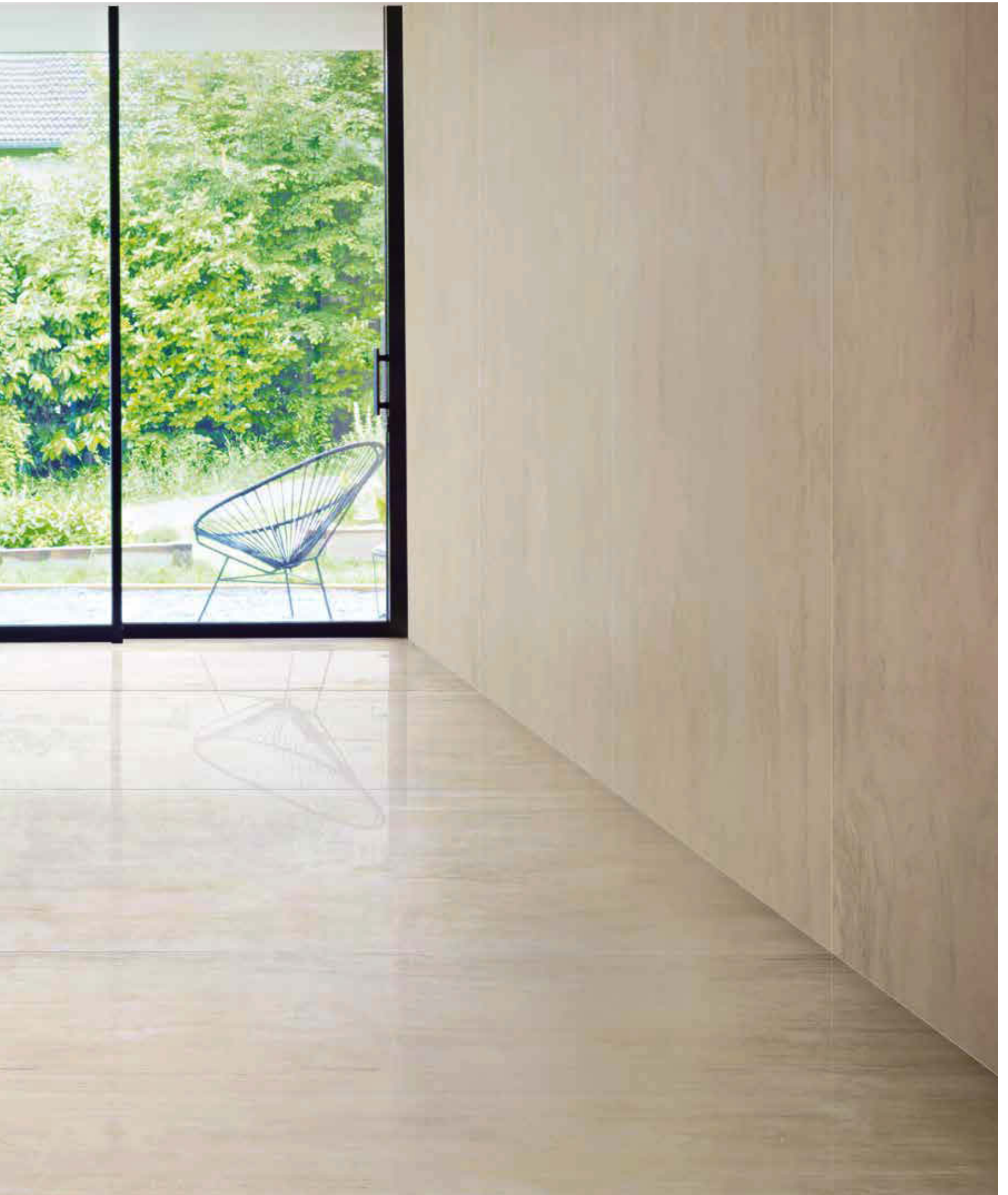

ULTRA MARMI
STATUARIO
ALTISSIMO





Floor: Statuario Altissimo Shiny, 300 x 150 cm

ULTRA MARMI STATUARIO ALTISSIMO MARBLE GRAIN CONTINUITY

Tutte le collezioni a grande formato ULTRA, pur sviluppando superfici native da 4,5 a 5,12 metri quadrati, dispongono di svariate texture dello stesso materiale, al fine di ottenere un effetto compositivo il più naturale ed eterogeneo possibile.

All of the large size ULTRA collections, covering native surfaces from 4,5 a 5,12 square metres, have a variety of textures in the same material, in order to achieve a compositional effect which is as natural and heterogeneous as possible.



Alle Kollektionen im Großformat ULTRA für die standardmäßigen Flächen von 4,5-5,12 qm sind in vielfältigen Oberflächentexturen für das gleiche Material erhältlich, wodurch man durch deren Zusammenstellungen einen so natürlich und einheitlichen Effekt wie nur möglich erzielen kann.

Toutes les collections en grand format ULTRA développent des surfaces traditionnelles de 4,5 à 5,12 m² et proposent une variété de textures du matériau, afin d'obtenir un effet de composition aussi naturel et hétérogène que possible.







ULTRA MARMI
STATUARIO ALTISSIMO

BOOK MATCH







Floor: Thassos Shiny, 300 x 150 cm



ULTRA MARMÌ
THASSOS



Floor and wall: Travertino Santa Caterina Shiny, 300 x 150 cm



ULTRA MARMI

TRAVERTINO
SANTA CATERINA



Floor: Travertino Santa Caterina Shiny, 300 x 150 cm



TAILORED
& LIGHTEST

ULTRA MARMI

ERAMOSA
BROWN



Wall: Eramosa Brown Shiny, 300 x 150 cm





Wall: Eramosa Brown Shiny, 300 x 150 cm



Wall: Zebrino Black Shiny, 300 x 150 cm





ULTRA MARMI

ZEBRINO BLACK

ULTRA MARMI

ESTREMOZ





Floor and wall: Estremoz Shiny, 300 x 150 cm



Floor and wall: Estremoz Shiny, 300 x 150 cm



ULTRA MARMI ESTREMOZ MARBLE GRAIN CONTINUITY

Tutte le collezioni a grande formato ULTRA, pur sviluppando superfici native da 4,5 a 5,12 metri quadrati, dispongono di svariate texture dello stesso materiale, al fine di ottenere un effetto compositivo il più naturale ed eterogeneo possibile.

All of the large size ULTRA collections, covering native surfaces from 4,5 a 5,12 square metres, have a variety of textures in the same material, in order to achieve a compositional effect which is as natural and heterogeneous as possible.



Alle Kollektionen im Großformat ULTRA für die standardmäßigen Flächen von 4,5-5,12 qm sind in vielfältigen Oberflächentexturen für das gleiche Material erhältlich, wodurch man durch deren Zusammenstellungen einen so natürlich und einheitlichen Effekt wie nur möglich erzielen kann.

Toutes les collections en grand format ULTRA développent des surfaces traditionnelles de 4,5 à 5,12 m² et proposent une variété de textures du matériau, afin d'obtenir un effet de composition aussi naturel et hétérogène que possible.





Floor and wall: Statuario Ultra Shiny, 300 x 150 cm

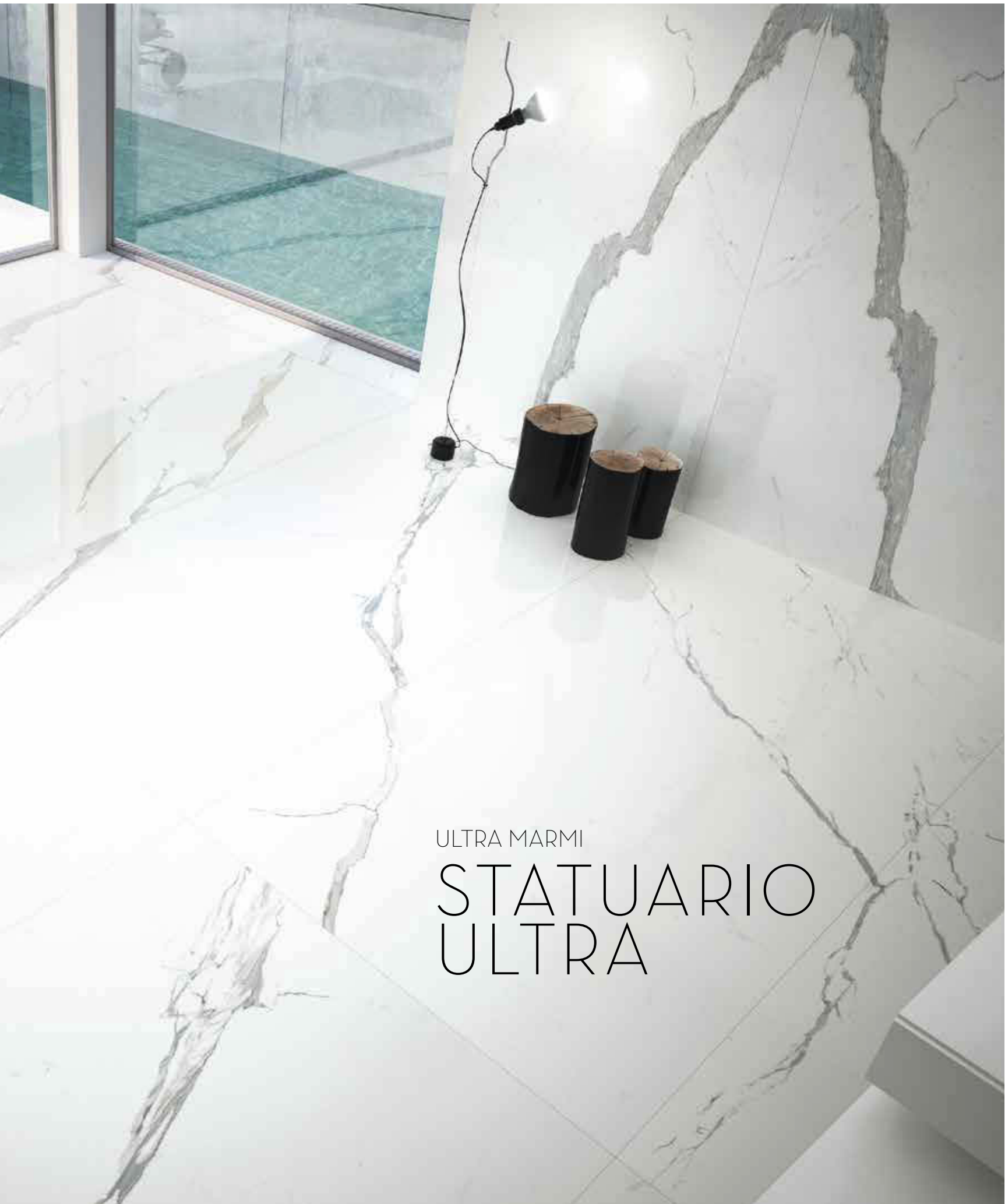

ULTRA MARMINI

STATUARIO ULTRA

ULTRA MARMI
STATUARIO ULTRA
BOOK
MATCH



Floor and wall: Statuario Ultra Shiny, 300 x 150 cm

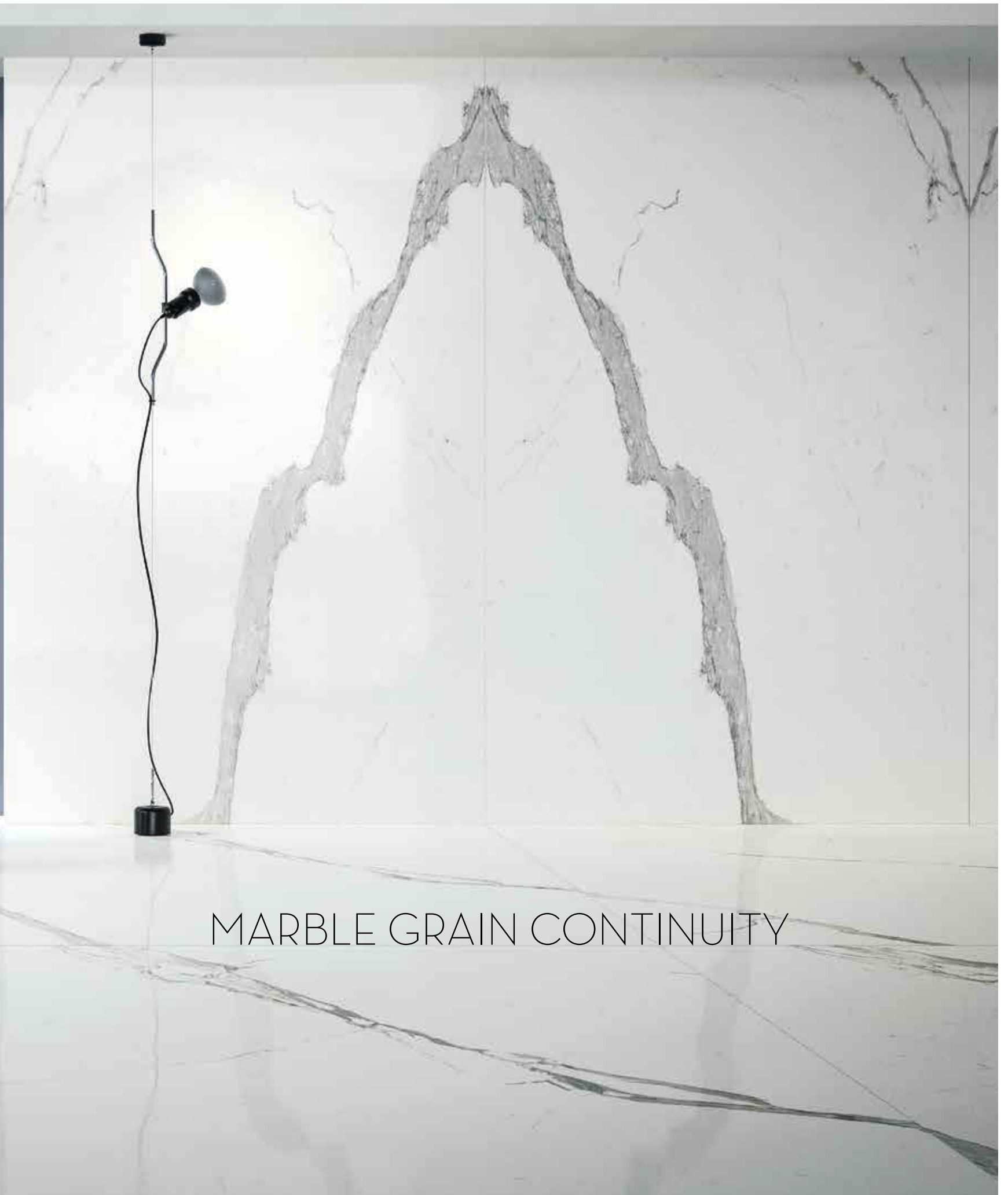

MARBLE GRAIN CONTINUITY

ONICI

L'eccezionalità del lusso si accompagna alla leggerezza del grande formato nel minimo spessore e conquista l'eccellenza nella pavimentazione e nel rivestimento di piccole e grandi superfici. La prestazione tecnica dei materiali si esalta nell'armonia dell'onice e sconfinata nel design garantendo omogeneità e flessibilità progettuale anche all'applicazione su oggetti e complementi d'arredo.

The exceptionality of its luxury combines with the light weight of the large size in the minimum thickness to conquer an excellence in flooring and coverings of surfaces both large and small. The technical performance of the materials comes to the fore in the harmony of the onyx and encroaches into the design guaranteeing a uniformity and flexibility of planning, even when applied to objects and furnishing accessories.

Außergewöhnlicher Luxus verbindet sich mit der Leichtigkeit des großen Formates bei zugleich geringster Dicke und verleiht so dem Bodenbelag und der Wandverkleidung kleiner und großer Oberflächen den Flair des ganz Besonderen. Die technischen Eigenarten des Materials begeistern durch die Harmonie des Onyx und nähern sich von sich aus schon dem Design, wobei sie gleichermaßen Homogenität und variable Einsetzbarkeit bieten, die auch zum Einsatz an Objekten und Einrichtungsgegenständen einladen.

Le luxe d'exception couplé à la légèreté d'un grand format d'épaisseur minimale permet d'obtenir un dallage et un recouvrement excellents des petites ainsi que des grandes surfaces. L'harmonie de l'Onyx sublime les prestations techniques des matériaux et leur dépassement par une conception qui en garantit l'homogénéité et la flexibilité dans tout projet, même pour des applications à des objets et des compléments ornementaux.

6/10_{mm} THICKNESS

3 COLORS

2 FINISHES



**300
x150**

*Disponibile per tutti i materiali.
Available for all materials.
Erhältlich für alle Materialien.
Disponibile pour tous les matériaux.*

**320
x160**

*È un formato a richiesta per tutti materiali.
Size on request for all materials.
Dieses Format kann auf Wunsch für alle Materialien angefordert werden.
Il s'agit d'un format sur demande pour tous les matériaux.*

ONICE BIANCO EXTRA

ONICE BEIGE

89

6 mm
THICKNESS

Disponibile per tutti i materiali e tutti formati.
Available for all materials and all sizes.
Erhältlich für alle Materialien und in allen Größenformaten.
Disponible pour tous les matériaux et tous les formats.

10 mm
THICKNESS

Disponibile a richiesta per tutti materiali.
Available on request for all materials.
Auf Anfrage für alle Materialien erhältlich.
Disponible sur demande pour tous les matériaux.





ULTRA ONICI
GRIGIO

Floor: Onice Grigio Shiny, 150 x 150 cm
Walls: Ebano Prelucidato, 300 x 100 cm



Floor: Onice Grigio Shiny, 150 x 150 cm

Walls: Ebano Prelucidato, 300 x 100 cm





Wall: Onice Bianco Extra Shiny, 300 x 150 cm
Floor: Onice Bianco Extra Shiny, 150 x 150 cm



ULTRA ONICI

BIANCO
EXTRA



ULTRA ONICI BIANCO EXTRA MARBLE GRAIN CONTINUITY

Tutte le collezioni a grande formato ULTRA, pur sviluppando superfici native da 4,5 a 5,12 metri quadrati, dispongono di svariate texture dello stesso materiale, al fine di ottenere un effetto compositivo il più naturale ed eterogeneo possibile.

All of the large size ULTRA collections, covering native surfaces from 4,5 a 5,12 square metres, have a variety of textures in the same material, in order to achieve a compositional effect which is as natural and heterogeneous as possible.



Alle Kollektionen im Großformat ULTRA für die standardmäßigen Flächen von 4,5-5,12 qm sind in vielfältigen Oberflächentexturen für das gleiche Material erhältlich, wodurch man durch deren Zusammenstellungen einen so natürlich und einheitlichen Effekt wie nur möglich erzielen kann.

Toutes les collections en grand format ULTRA développent des surfaces traditionnelles de 4,5 à 5,12 m² et proposent une variété de textures du matériau, afin d'obtenir un effet de composition aussi naturel et hétérogène que possible.



ULTRA ONICI
BEIGE



Wall: Onice Beige Shiny, 300 x 150 cm







Wall: Onice Beige Shiny, 300 x 150 cm



METAL

Brillante, sofisticata ed incisiva, così si presenta la collezione Ultra Metal, che arricchisce il mondo delle grandi Lastre di una nuova potenza estetica, ispirata alle proprietà dei metalli. Superfici e rivestimenti ricavati dall'emozione, la meraviglia e l'insegnamento che la natura ha saputo regalare all'uomo per ambire ad architetture futuribili e nuovi traguardi.

Brilliant, sophisticated and incisive, this is how the Ultra Metal collection looks. It embellishes the world of big slabs with a new aesthetic power, inspired by the properties of the metals. Surfaces and coatings obtained through emotion, the wonder and teaching that nature has been able to pass over to mankind to aspire to futuristic architecture and new standards.

Brillant, anspruchsvoll und einprägend: das sind die Merkmale der Sammlung Ultra Metal, die die Welt der großen Platten um eine neue Ästhetik bereichert, die sich an den Eigenschaften der Metalle inspiriert. Oberflächen und Beschichtungen aus Emotionen. Das Wunder, das die Natur dem Menschen schenkte, um neue Ziele und futuristische Architektur anzustreben.

Brillante, sophistiquée et incisive, c'est ainsi que se présente la collection Ultra Metal, qui enrichit le monde des grandes Plaques d'une nouvelle puissance esthétique, inspirée de la propriété des métaux. Surfaces et revêtements obtenus par l'émotion, l'émerveillement et l'enseignement que la nature a su donner à l'homme pour aspirer à de nouveaux objectifs et à des architectures futuribles.

6/10_{mm} THICKNESS
3 COLORS
SOFT FINISH



BROWN ZINC

300
x150

Disponibile per tutti i materiali.
Available for all materials.
Erhältlich für alle Materialien.
Disponible pour tous les matériaux.

320
x160

È un formato a richiesta per tutti i materiali.
Size on request for all materials.
Dieses Format kann auf Wunsch für alle Materialien angefordert werden.
Il s'agit d'un format sur demande pour tous les matériaux.



6 mm
THICKNESS

Disponibile per tutti i materiali e tutti formati.
Available for all materials and all sizes.
Erhältlich für alle Materialien und in allen Größenformaten.
Disponible pour tous les matériaux et tous les formats.

10 mm
THICKNESS

Disponibile a richiesta per tutti materiali.
Available on request for all materials.
Auf Anfrage für alle Materialien erhältlich.
Disponible sur demande pour tous les matériaux.





ULTRA METAL
BLUE
ZINC

Floor: Blue Zinc Soft, 300 x 150 cm







Floor: Blue Zinc Soft, 300 x 150 cm



ULTRA METAL
GREY
ZINC





Wall: Grey Zinc Soft, 300 x 150 cm

Wall: Grey Zinc Soft, 300 x 150 cm





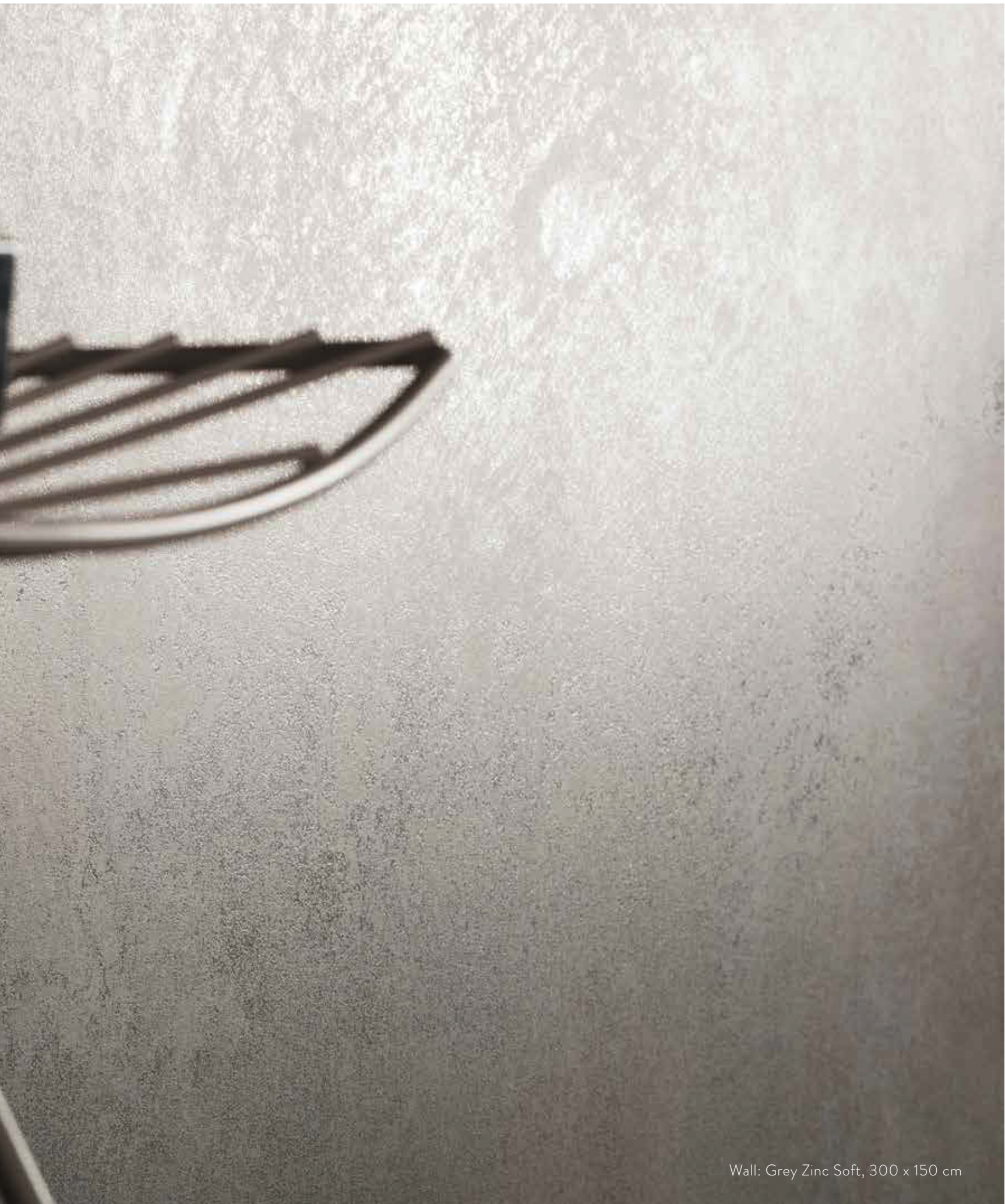





ULTRA METAL
BROWN
ZINC

Floor: Brown Zinc Soft, 150 x 150 cm



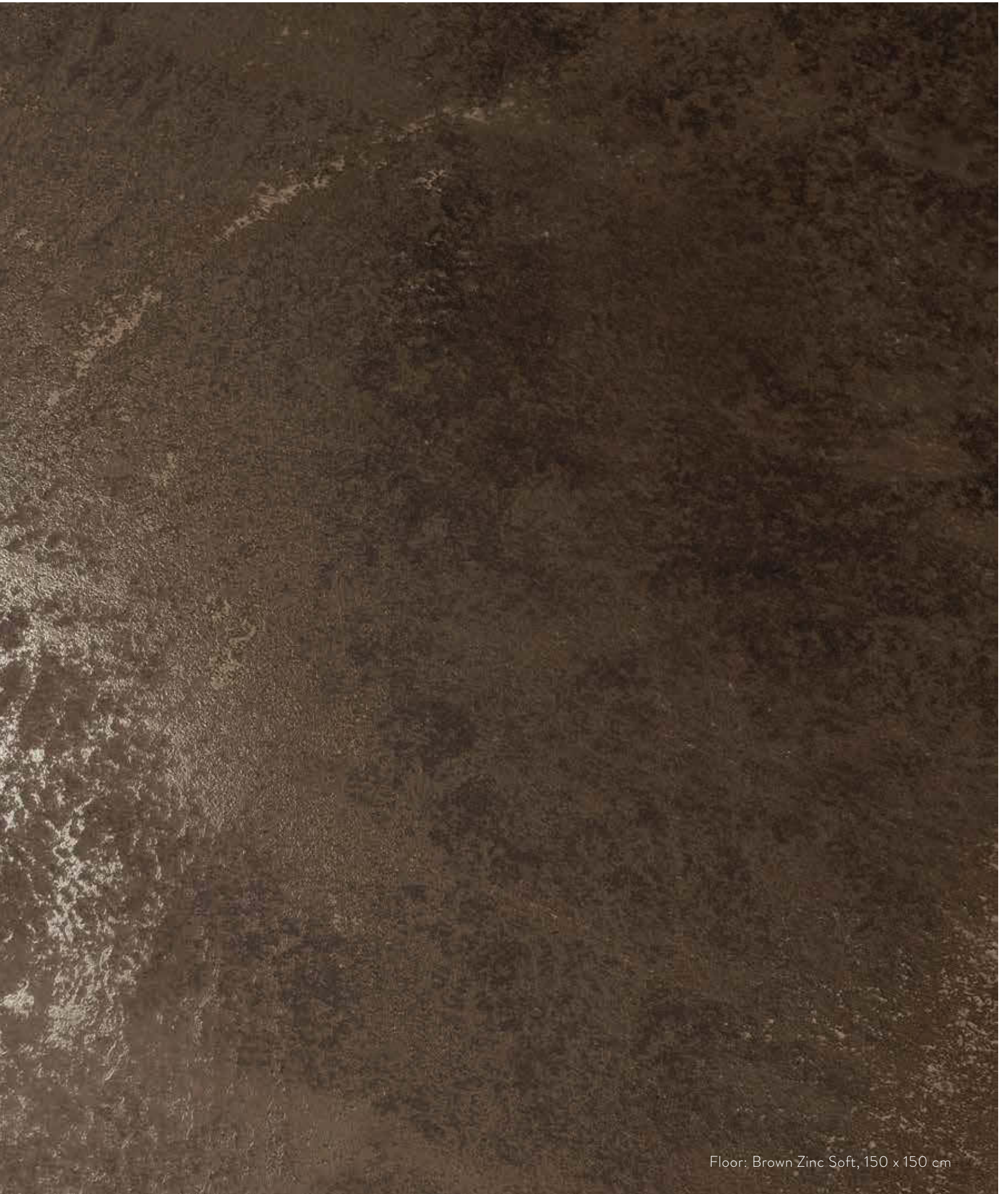

BIANCO

IRIDIUM

120

6_{mm} THICKNESS
10_{mm} THICKNESS
3 COLORS
2 FINISHES

300
x150

*Disponibile per tutti i materiali.
Available for all materials.
Erhältlich für alle Materialien.
Disponible pour tous les matériaux.*

320
x160

*È un formato a richiesta per tutti materiali.
Size on request for all materials.
Dieses Format kann auf Wunsch für alle Materialien angefordert werden.
Il s'agit d'un format sur demande pour tous les matériaux.*

GRIGIO

NERO

121

6 mm
THICKNESS

Disponibile per tutti i materiali e tutti formati.
Available for all materials and all sizes.
Erhältlich für alle Materialien und in allen Größenformaten.
Disponible pour tous les matériaux et tous les formats.

10 mm
THICKNESS

Disponibile a richiesta per tutti materiali.
Available on request for all materials.
Auf Anfrage für alle Materialien erhältlich.
Disponible sur demande pour tous les matériaux.

ULTRA IRIDIUM

BIANCO,
NERO &
GRIGIO

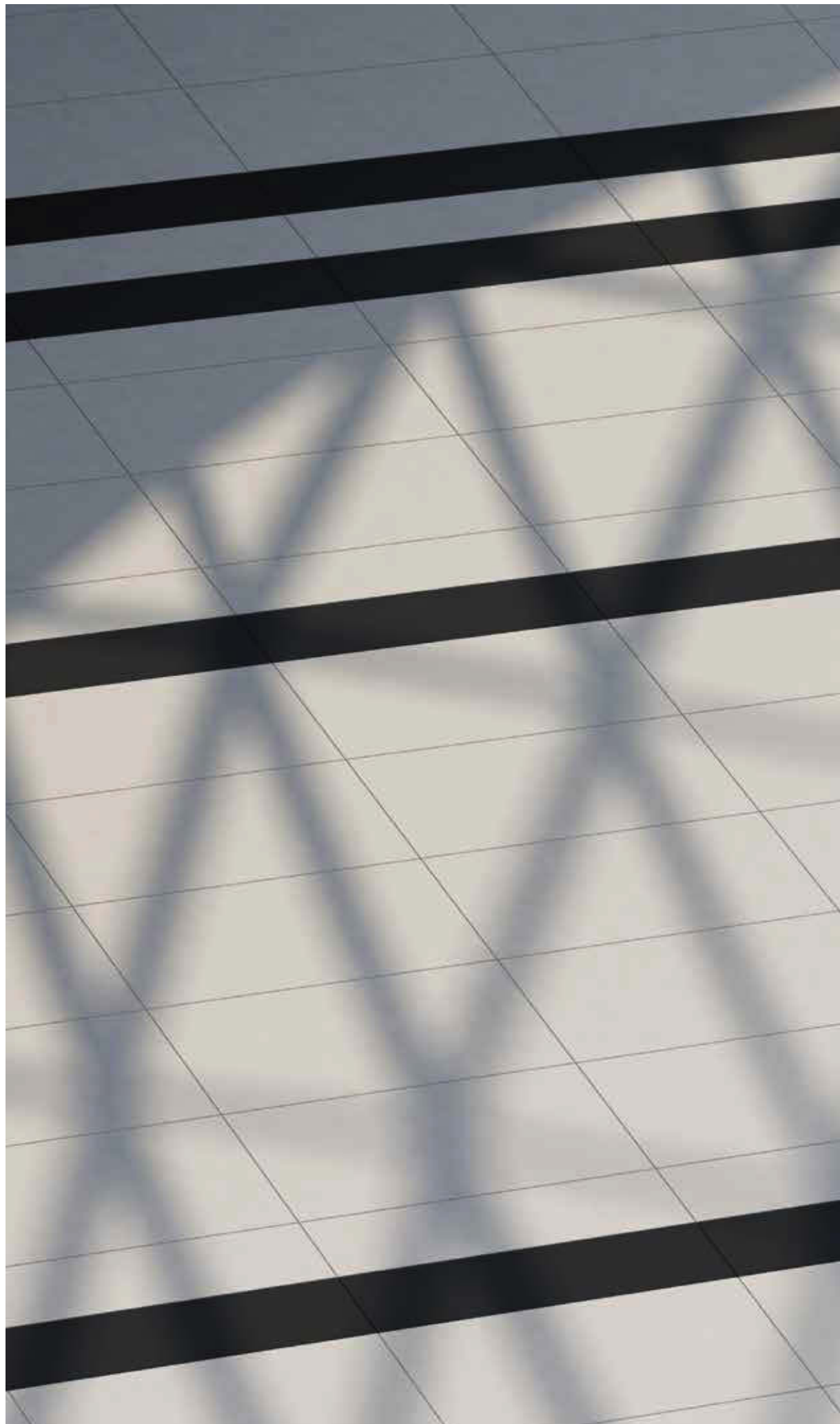



Floor: Bianco, Nero, Grigio Soft, 300 x 150 cm



iCementi

iCementi Ariostea nel grande formato 300x150 restituiscono le sensazioni del materiale eterno per eccellenza, conferendo alle superfici rivestite un sapore familiare e affascinante allo stesso tempo. Le elevate prestazioni meccaniche ed estetiche delle lastre Ultra garantiscono al progettista la resistenza superficiale necessaria ed un sicuro impatto emotivo pur senza veicolare le problematiche tipiche del materiale a cui si ispirano. Il dualismo di leggerezza e minimo spessore, insieme all'effetto caldo e ruvido del cemento offrono piacevoli contrasti e aprono nuovi orizzonti progettuali.

iCementi Ariostea with their 300x150 size restore sensations typical of eternal materials, giving surfaces a familiar taste and a fascinating air at the same time. Ultra slabs technical and aesthetical features assure designers both great resistance and a strong emotional impact, with none of the limits typical of the original materials that have inspired them. The twin properties of lightness and minimal thickness, as well as a roughly warm cement effect offer pleasing contrasts and open up new horizons for design.

iCementi Ariostea geben mit ihrem Großformat 300x150 das Gefühl von absolut ewigem Material und verleihen den damit verkleideten Flächen einen gleichermaßen faszinierenden wie vertrauten Eindruck. Die hohe mechanische Belastbarkeit und die ästhetischen Vorzüge der Platten Ultra garantieren dem Projektverantwortlichen die nötige Oberflächenbelastbarkeit und eine gesicherte Anmutung, ohne dabei die Probleme zu entwickeln, die für das sie inspirierende Material typisch sind. Die Kombination von Leichtigkeit und sehr geringer Plattendicke, vereint mit dem warmen und rauen Eindruck von Beton, bieten ansprechende Kontraste und eröffnen neue Entwurfsmöglichkeiten.

iCementi Ariostea en grand format 300x150 redonnent les sensations du matériel éternel par excellence, en conférant aux surfaces revêtues une saveur familiale et fascinante en même temps. Les prestations mécaniques élevées et celles esthétiques des dalles Ultra garantissent au concepteur la résistance nécessaire de la surface et un fort impact émotif sans véhiculer les problématiques typiques du matériel auquel elles s'inspirent. La combinaison entre légèreté et fine épaisseur, ajouté à l'effet chaud et rugueux du ciment, offre de plaisants contrastes et ouvre à de nouveaux horizons projectuels.

6/10_{mm} THICKNESS
5 COLORS
SOFT FINISHES

**300
x150**

*Disponibile per tutti i materiali.
Available for all materials.
Erhältlich für alle Materialien.
Disponible pour tous les matériaux.*

**320
x160**

*È un formato a richiesta per tutti i materiali.
Size on request for all materials.
Dieses Format kann auf Wunsch für alle Materialien angefordert werden.
Il s'agit d'un format sur demande pour tous les matériaux.*



6 mm
THICKNESS

Disponibile per tutti i materiali e tutti formati.
Available for all materials and all sizes.
Erhältlich für alle Materialien und in allen Größenformaten.
Disponibile pour tous les matériaux et tous les formats.

10 mm
THICKNESS

Disponibile a richiesta per tutti materiali.
Available on request for all materials.
Auf Anfrage für alle Materialien erhältlich.
Disponibile sur demande pour tous les matériaux.



Wall: Iron Soft, 300 x 150 cm



ULTRA iCementi
IRON



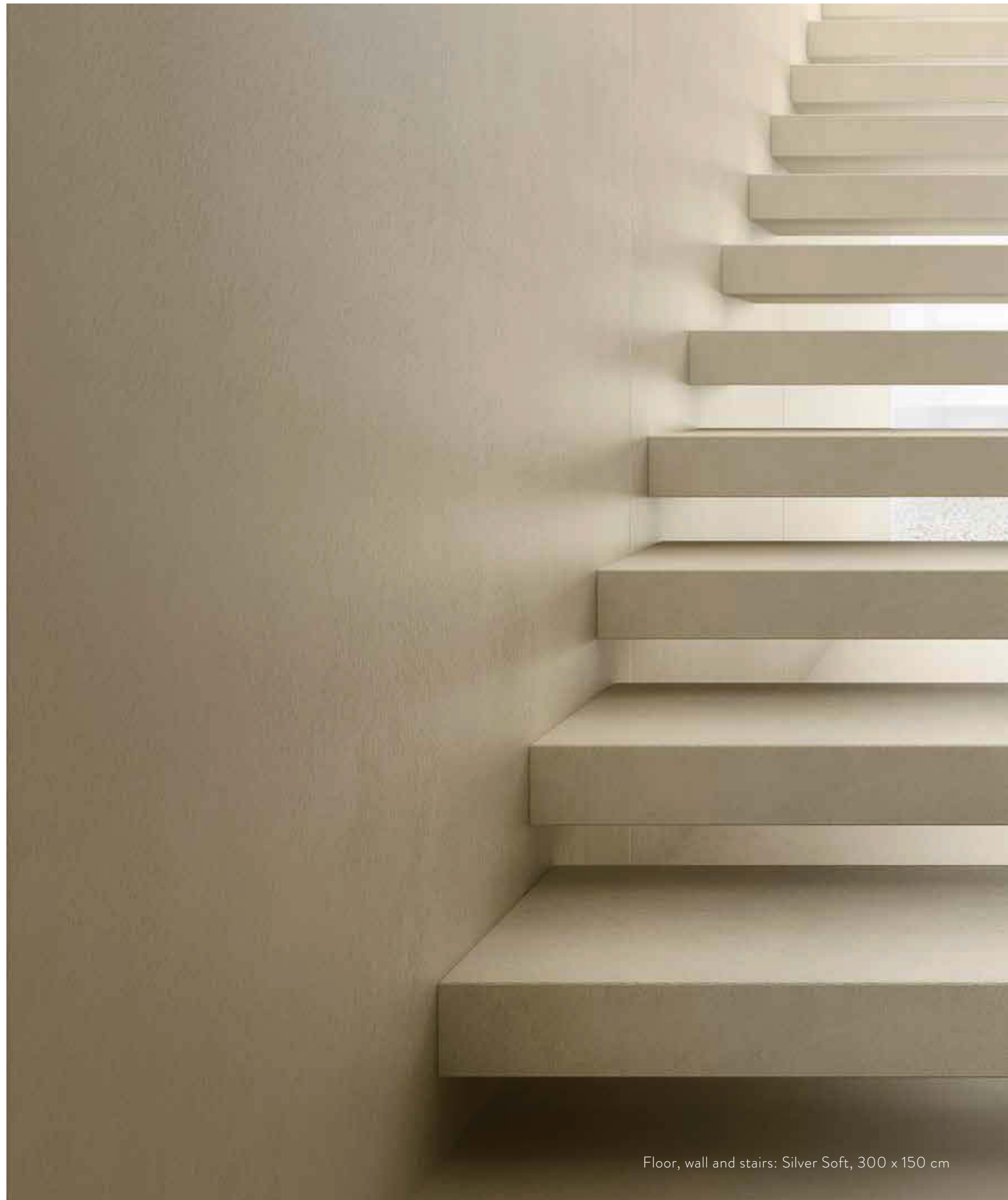

Floor, wall and stairs: Silver Soft, 300 x 150 cm



ULTRA iCementi
SILVER

Floor, wall and stairs: Silver Soft, 300 x 150 cm

130

Floor: Graphite Soft, 150 x 150 cm





131

ULTRA iCementi
GRAPHITE

CONTEMPORARY CONCRETE

Floor: Bronze Soft, 150 x 150 cm



ULTRA iCementi

BRONZE



Floor: Ivory Soft, 150 x 150 cm



ULTRA iCementi

IVORY

PIETRE

Ariosteas allarga la famiglia delle Pietre basata su tecnologia Ultra. Finissime lastre in 6 mm di spessore evocano la brutalità e l'eleganza delle Limestone e delle rocce effusive di origine vulcanica con una varietà di movimenti e stratificazioni difficilmente reperibili nelle rocce da estrazione. Le splendide tonalità delle Basaltine trovano larga applicazione nei vari settori dell'arredamento e del rivestimento, grazie alle differenti colorazioni: da quelle chiare della Basaltina White a quelle calde e corpose della Basaltina Moka, fino a quelle più scure e caratteristiche della stratificazione magmatica evocate dalla Basaltina Antracite. Le strutture superficiali delle Limestone giocano con la luce in maniera discreta ed emozionale, donando agli ambienti una ricca sensazione di luminosità e calore domestico.

Ariosteas is extending Pietre's family based on Ultra technology. Very fine 6 mm thick slabs evoke brutality and elegance of Limestone and effusive volcanic rocks with a variety of patterns and stratification hard to find in extraction rocks. Basaltine beautiful shades find large use in many furniture and covering applications thanks to their variety of colours: from bright Basaltina White to warm and full-bodied Basaltina Moka, up to Basaltina Antracite darker and distinguishing magmatic stratifications. Limestone superficial structure play with light in a delicate and sensitive way, giving a rich feeling of brightness and domestic warmth to space.

Ariosteas erweitert den Umkreis zueinander verwandter Pietre, die auf der Ultra-Technologie beruhen. Feinste Platten mit 6 mm Stärke erwecken die Wuchtigkeit und die Eleganz von Kalksteinen und Effusivgesteinen vulkanischen Ursprungs, welche eine Vielfalt an Ebenen und Schichten aufweisen, die ansonsten selten beim Felsabbau zu beobachten sind. Die schönen Schattierungen von Basaltine finden breite Anwendung in verschiedenen Sektoren der Inneneinrichtung und Zimmerverkleidungen dank ihrer unterschiedlichen Kolorationen: von hellen Farben wie Basaltina White über warme und kräftige Farben wie Basaltina Moka bis zu dunkleren Tönen, welche typisch für magmatische Ablagerungen sind, so wie dies Basaltina Antracite zeigt. Die Oberflächenstrukturen des Limestone spielen mit dem Licht in einer unaufdringlichen und gefühlvollen Weise und verleihen Räumen somit reichhaltige Lichteindrücke und häusliche Wärme.

Ariosteas élargit la famille des Pietre basée sur la technologie Ultra. Les plaques très fines de 6 mm d'épaisseur évoquent le caractère brut et l'élégance du calcaire et des roches effusives d'origine volcanique, avec une variété de mouvements et de stratifications qu'on trouve difficilement dans les roches d'extraction minière. Les superbes nuances des Basaltine ont une large application dans les différents secteurs de l'ameublement et du revêtement, grâce aux différents coloris qu'elles offrent : du clair de la Basaltina White à la chaleur et à la richesse de la Basaltina Moka, jusqu'aux tons plus sombres et caractéristiques de la stratification magmatique qu'on retrouve dans la Basaltina Antracite. Les structures de surface des Limestone jouent avec la lumière de manière discrète et transmettent des émotions, enrichissant les espaces d'une sensation de luminosité et de chaleur domestique.

6_{mm} THICKNESS
8 COLORS
2 FINISHES

300
x100

Disponibile per tutti i materiali.
Available for all materials.
Erhältlich für alle Materialien.
Disponibile pour tous les matériaux.

100
x100

Disponibile per tutti i materiali.
Available for all materials.
Erhältlich für alle Materialien.
Disponibile pour tous les matériaux.



BASALTINA ANTRACITE

SAN VICENTE LIMESTONE



BASALTINA GREY

AZUL BATEIG LIMESTONE



BASALTINA MOKA

JERUSALEM LIMESTONE



BASALTINA SAND



BASALTINA WHITE





ULTRA PIETRE
LIMESTONE



SAN VICENTE LIMESTONE

AZUL BATEIG LIMESTONE

JERUSALEM LIMESTONE



140

Floor: Jerusalem Limestone Structured, 100 x 100 cm

ULTRA PIETRE

JERUSALEM

LIMESTONE



ULTRA PIETRE

AZUL BATEIG

LIMESTONE







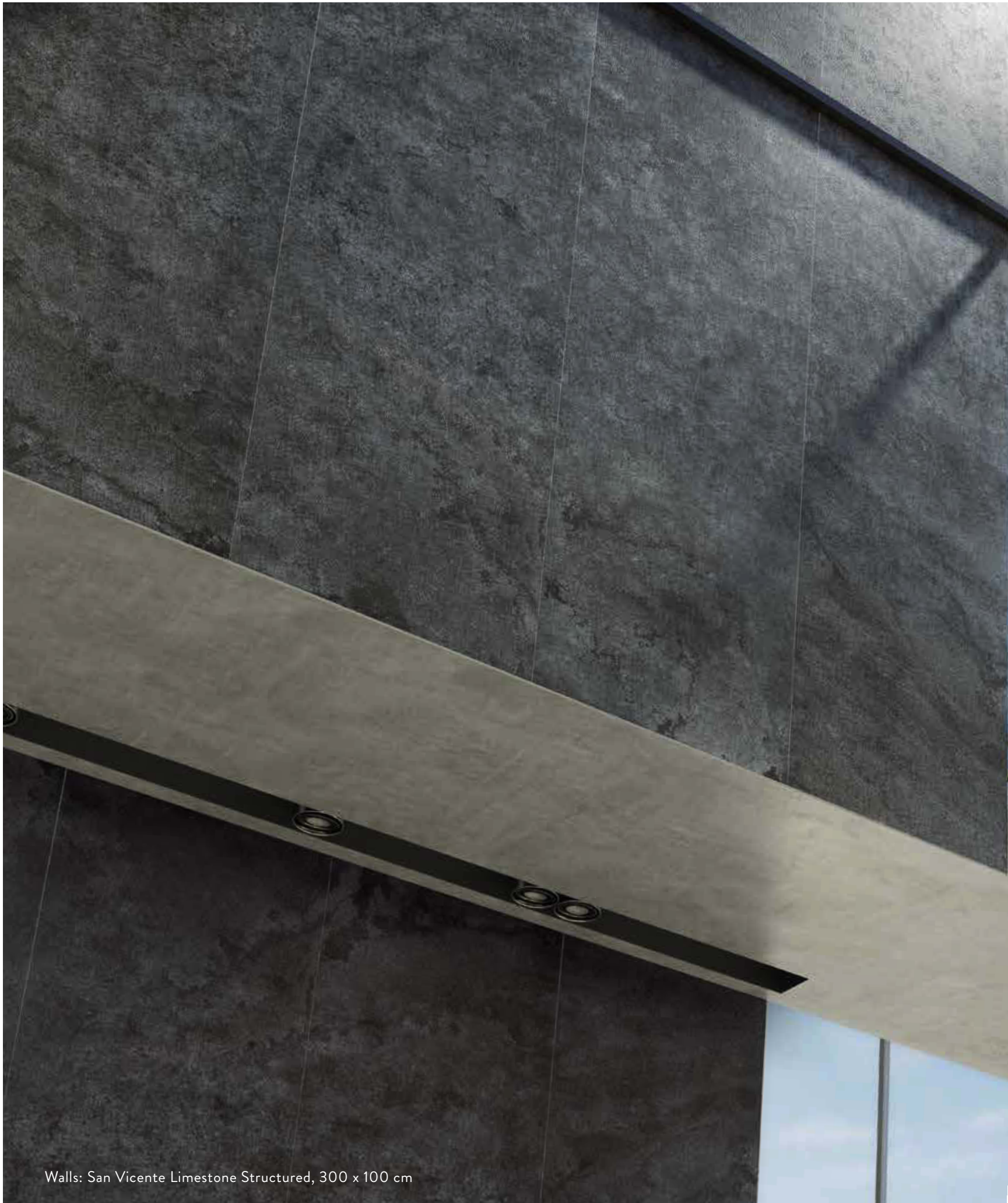

Walls: San Vicente Limestone Structured, 300 x 100 cm



ULTRA PIETRE

SAN VICENTE

LIMESTONE



ULTRA PIETRE
BASALTINE



BASALTINA GREY



BASALTINA WHITE



BASALTINA SAND



BASALTINA MOKA



BASALTINA ANTRACITE

FLOOR & WALL

BEDROOM

KITCHEN

LIVING

HOMESPA

OFFICE **RETAIL**

BATHROOM





Floor: Basaltina Moka Soft, 100 x 100 cm



ULTRA PIETRE

BASALTINA
MOKA



Floor: Basaltina Sand Soft, 100 x 100 cm

ULTRA PIETRE
BASALTINA
SAND



ULTRA PIETRE
BASALTINA
WHITE



Floor: Basaltina White Soft, 100 x 100 cm





Floor: Basaltina White Soft, 100 x 100 cm



Wall: Basaltina Grey Soft, 100 x 100 cm





Wall: Basaltina Grey Soft, 100 x 100 cm

ULTRA PIETRE
BASALTINA
GREY





Floor: Basaltina Antracite Soft, 100 x 100 cm



ULTRA PIETRE

BASALTINA
ANTRACITE

RESINE

La tecnologia Ultra si è spinta fino alla realizzazione di superfici strutturate di grande formato con l'obiettivo di trasmettere sensazioni morbide alla vista e gradevoli al tatto. Nasce così la collezione Ultra Resine in una gamma di colorazioni dai toni caldi in grado di rendere lo spazio avvolgente e vellutato. I rivestimenti in Ultra Resine, grazie alle proprietà compositive del materiale, esaltano il carattere uniforme e moderno degli ambienti contemporanei, superando la bidimensionalità delle superfici ceramiche convenzionali.

Ultra technology lead up to create structured surfaces in large size with the aim of transmitting soft sensations to sight and mellow to touch. Therefore the Ultra Resine collection get birth in a range of warm colors, capable to render enchanting and velvety the space. Coatings in Ultra Resine, thanks to material compositive properties, accent the uniform and modern contemporary environments, overcoming the two-dimension of conventional ceramic surfaces.

Die Entwicklung der Ultra-Technologie hat bis zur Erschaffung großflächig strukturierter Oberflächen geführt, die weich aussehen und sich angenehm anfühlen sollen.

Auf diesem Wege ist auch die Kollektion Ultra Resine entstanden, die mit ihren warmen Farbtönen ein gemütliches und samtweiches Ambiente schafft.

Die Ultra Resine heben dank der vielseitigen Eigenschaften des Materials den uniform-modernen Charakter zeitgenössischer Wohnräume hervor und übertrifft damit die Zweidimensionalität herkömmlicher Keramikoberflächen.

La technologie Ultra est arrivée jusqu'à la réalisation de surfaces structurées grand format, dans le but de transmettre des sensations agréables à la vue et doux à la touche. C'est ainsi que naît la collection Ultra Resine dans une gamme de colorations aux tons chaleureux, idéale pour que l'espace devienne accueillant et velouté.

Grâce aux propriétés du matériau composé, les revêtements Ultra Resine mettent en valeur le caractère uniforme et moderne des espaces contemporains et ne s'arrêtent pas à la bidimensionnalité des surfaces en céramique traditionnelles.

6 mm THICKNESS
4 COLORS
2 FINISHES

SILICIO



PIOMBO

EBANO

CALCE



300
x100

Disponibile per tutti i materiali.
Available for all materials.
Erhältlich für alle Materialien.
Disponible pour tous les matériaux.

100
x100

Disponibile per tutti i materiali.
Available for all materials.
Erhältlich für alle Materialien.
Disponible pour tous les matériaux.



ULTRA RESINE

EBANO



Wall: Silicio Soft, 300 x 100 cm
Floor: Piombo Soft, 100 x 100 cm



ULTRA RESINE
SILICIO



170

Floor: Piombo Soft, 100 x 100 cm



ULTRA RESINE

PIOMBO

ULTRA RESINE
CALCE



Floor: Calce Soft, 100 x 100 cm





Floor: Calce Soft, 100 x 100 cm



La finitura prelucidato viene applicata su alcuni prodotti Ultra e conferisce un aspetto raffinato ed elegante al materiale.

E' sufficiente tralucare la lastra per intuire immediatamente le potenzialità estetiche e pratiche della finitura stessa; la struttura superficiale mantiene infatti tutte le peculiarità del materiale nativo, ma si impreziosisce di cangianze e riflessi particolarmente elaborati grazie all'interazione con la luce e l'ambiente.

The prelucidato finish is applied on some Ultra products and it gives the material a refined and elegant look.

It is enough just to have a quick look at the plate to immediately understand the aesthetic and practical potential of this finish; the characteristics of the surface structure's native material is unaltered, and in fact it is embellished with particularly elaborate iridescent reflections caused by interaction with the light and the environment.

PRELUCIDATO

Die Veredelung prelucidato wird auf einigen Ultra Produkten angewendet und gibt dem Material ein raffiniertes und elegantes Aussehen.

Man braucht nur die Platte betrachten, um sofort die ästhetischen und praktischen Möglichkeiten der Veredelung zu erkennen; die Oberflächenstruktur behält alle Besonderheiten des ursprünglichen Materials bei, aber wird mit einem Schimmer und speziell ausgearbeiteten Reflexen durch die Interaktion zwischen Licht und Umwelt veredelt.

La finition prelucidato est appliquée sur certains produits Ultra et donne un look raffiné et élégant à la matière.

Il suffit de regarder la plaque pour remarquer immédiatement les potentiels esthétiques et pratiques de la finition elle-même ; en effet la structure de la surface garde toutes les particularités de la matière d'origine, mais elle enrichit de reflets irisés et particulièrement élaborés grâce à l'interaction avec la lumière et l'environnement.

METRO

ULTRA TECHNOLOGY by ARIOSTEA HIGH-TECH

La famiglia METRO nasce per riproporre alcune collezioni nel formato 1 x 1. Basato sul nativo 300 x 100 cm, il formato quadrato oltre ad abbattere i costi di trasporto e montaggio, offre il vantaggio di una più semplice gestione e manovrabilità nei cantieri e nelle ristrutturazioni.

ULTRAIRIDIUM

BIANCO

NERO

ULTRAPIETRE

BASALTINA ANTRACITE

ULTRAPIETRE

JERUSALEM LIMESTONE

AZUL BATEIG LIMESTONE

SAN VICENTE LIMESTONE

ULTRAiCementi

BRONZE

SILVER

IVORY

IRON

GRAPHITE

The METRO family was created to revive some collections in the 1 x 1 size. Based on the native 300 x 100 cm size, on top of reducing the costs of transport and assembly, the square format also has the advantage of being easier to handle and manoeuvre around construction and renovation sites.

Die Produktgruppe METRO wurde entwickelt, um einige Kollektionen durch deren Wiederbelebung im Format 1 x 1 ebenfalls anbieten zu können. Auf dem standardmäßigen Format 300x100 cm beruhend, kann eine quadratische Form nicht nur unter Senkung der Transport- und Montagekosten angeboten werden, sondern auf dieser Grundlage werden auch die Anwendungsbedingungen und die Handhabung auf Baustellen oder während Renovierungsarbeiten vereinfacht.

La gamme METRO a été créée pour faire revivre certaines collections dans le format 1 x 1. Basé sur le format traditionnel 300 x 100 cm, le format carré, en plus de réduire les coûts de transport et de montage, présente l'avantage de faciliter la gestion et la manipulation sur les chantiers et les rénovations.



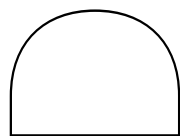
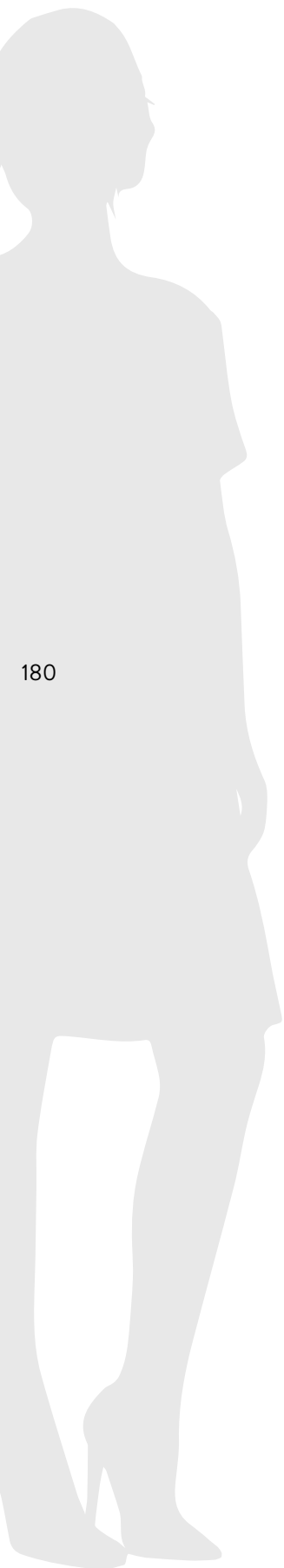

L'elegante tessitura lignea del Noce con le sue formidabili nodosità e striature verticali è proposta dalla nuova collezione ULTRA WOOD nel singolo grande formato 180x21,5 cm. Ariostea interpreta le caratteristiche di durezza e resistenza riconoscibili in questa essenza nei 5 diversi colori e nello spessore di 6 mm.

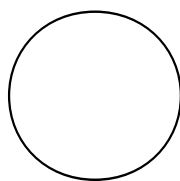

Walnut refined wooden weaving with its extraordinary knottiness and vertical stripes is proposed by the ultimate ULTRA WOOD collection in single 180x21,5 cm size. Ariostea impresses hardness and resistance recognizable properties of this essence in 5 different colours and in 6 mm thick tiles.

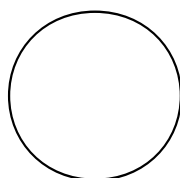

Die elegante Holz Textur des Nussbaumes mit seine formidabile Knorrigkeit und eine vertikale Streifung wird in der neuen Kollektion angeboten: ULTRA WOOD im einzelnen Großformat 180x21,5 cm. Ariostea interpretiert die Eigenschaften der Härte und Beständigkeit erkennbar, unter dieser Essenz, in 5 verschiedene Farben und in der Dicke von 6 mm.

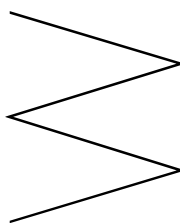

L'élégante texture en bois de noyer avec ses nœuds formidables et ses veines verticales est offerte dans la nouvelle collection ULTRA WOOD en grand format seulement 180 x 21,5 cm. Ariostea interprète les caractéristiques de résistance et de dureté reconnaissables dans cette essence dans 5 différents coloris et en épaisseur de 6 mm.

6_{mm} THICKNESS
SIZE 180 x 21,5_{cm}
5 COLORS
SOFT FINISH



NOCE SCURO



NOCE OSSIDATO



NOCE CALCE



NOCE CHIARO



NOCE AMERICANO



ULTRA WOOD
NOCE
AMERICANO





Floor and walls: Noce Americano Soft, 180 x 21,5 cm

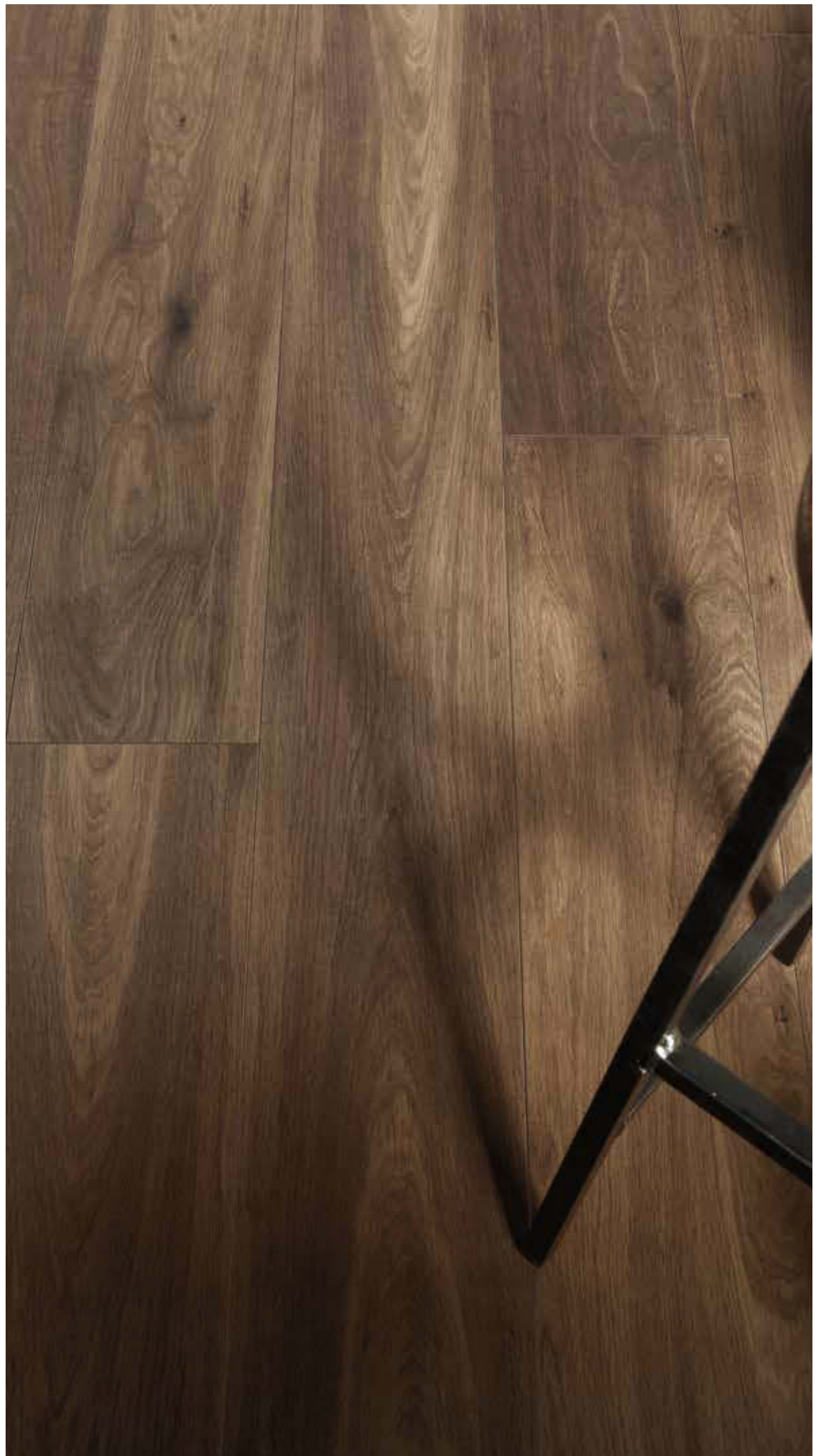



ULTRA WOOD

NOCE
OSSIDATO

Floor: Noce Ossidato Soft, 180 x 21,5 cm









Floor: Noce Scuro Soft, 180 x 21,5 cm



ULTRA WOOD

NOCE
SCURO







Floor: Noce Calce Soft, 180 x 21,5 cm



ULTRA WOOD

NOCE CALCE



Floor: Noce Calce Soft, 180 x 21,5 cm

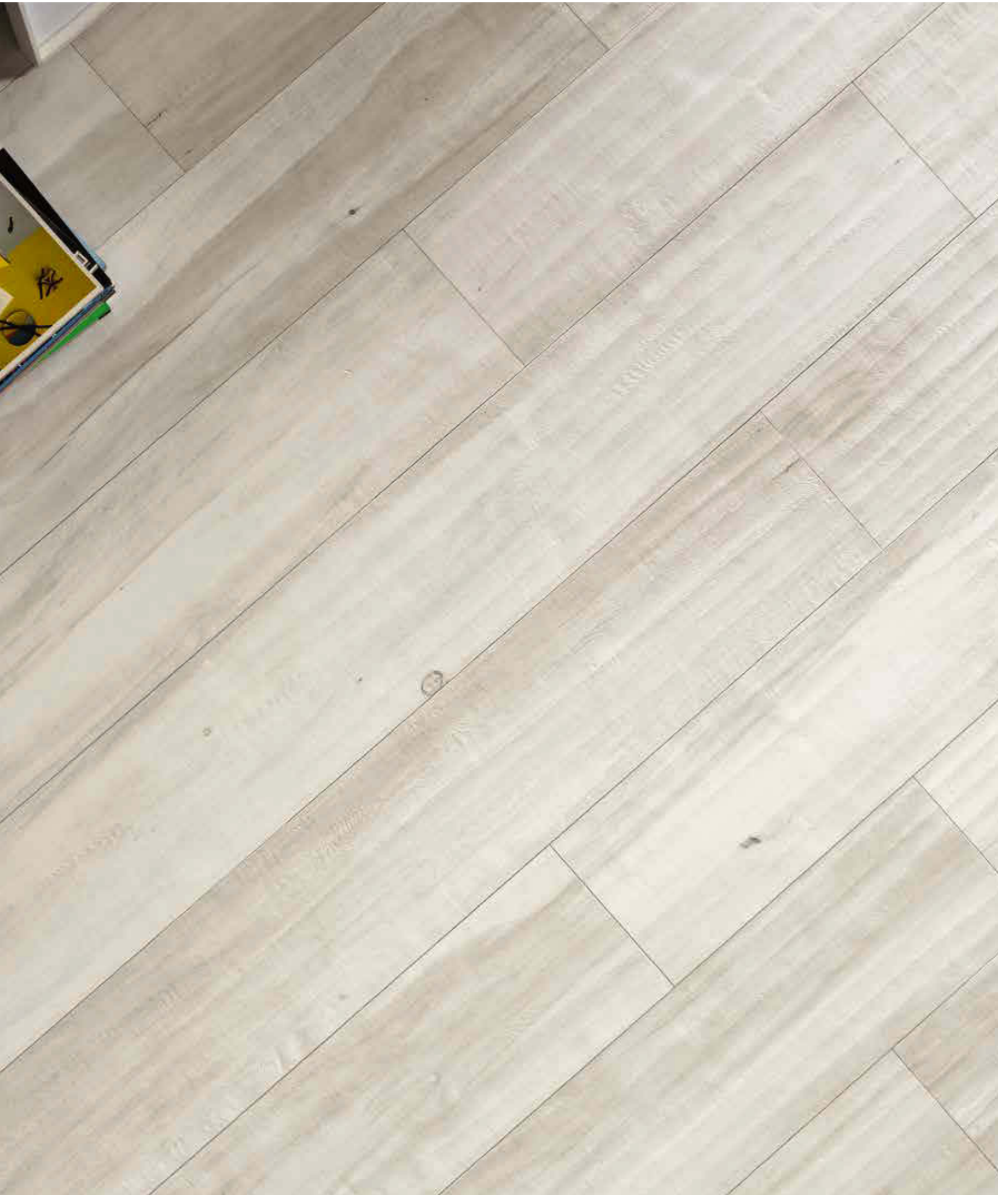



Floor: Noce Calce Soft, 180 x 21,5 cm





200

Floor: Noce Chiaro Soft, 180 x 21,5 cm



ULTRA WOOD

NOCE
CHIARO



Floor: Noce Chiaro Soft, 180 x 21,5 cm

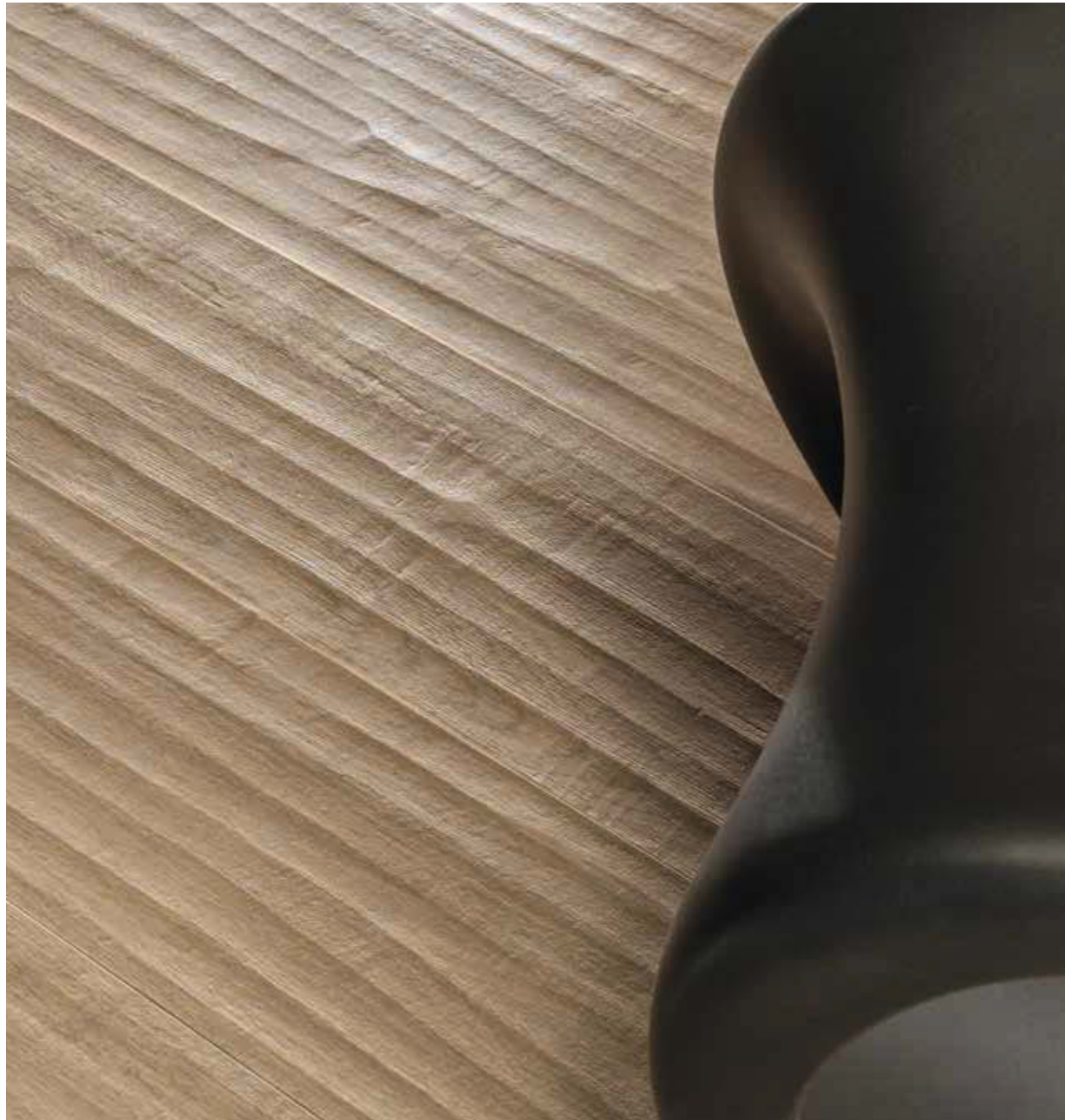

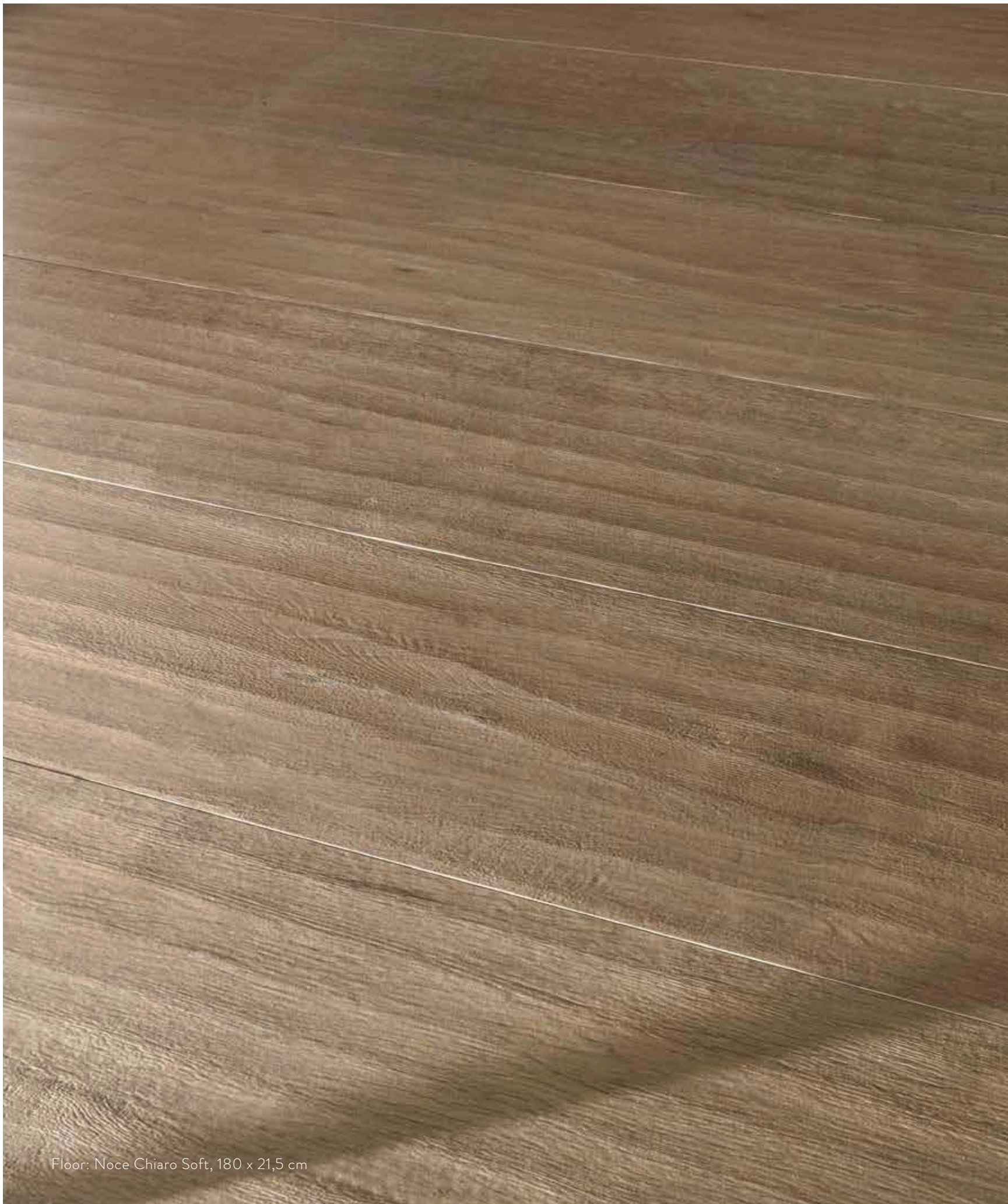

Floor: Noce Chiaro Soft, 180 x 21,5 cm



Max Ernst da collezioni francesi e italiane

Dopo le mostre di Robert Rauschenberg e Jasper Johns, il museo di New York ha organizzato una mostra di Max Ernst, un artista che ha trascorso la sua vita a viaggiare tra Parigi e New York. La mostra è curata da Robert Rauschenberg e Jasper Johns, due artisti che hanno lavorato con Ernst per molti anni. La mostra è divisa in due parti: la prima parte è dedicata alle opere di Ernst realizzate in Francia, la seconda parte è dedicata alle opere realizzate negli Stati Uniti. La mostra è una grande occasione per vedere le opere di Ernst in un'unica sede.

Max Ernst è nato a Brno, in Repubblica Ceca, nel 1891. Si trasferì a Parigi nel 1918, dove si unì al movimento Dada. Dopo la guerra, si trasferì a New York nel 1945, dove si unì al movimento Surrealista. Ernst è considerato uno dei più importanti artisti del XX secolo. Le sue opere sono caratterizzate dall'uso di tecniche miste, come il collage e il frottage. Le sue opere sono state acquistate da musei e collezionisti di tutto il mondo.

La mostra di New York è la prima mostra di Ernst negli Stati Uniti da oltre 20 anni. La mostra è curata da Robert Rauschenberg e Jasper Johns, due artisti che hanno lavorato con Ernst per molti anni. La mostra è divisa in due parti: la prima parte è dedicata alle opere di Ernst realizzate in Francia, la seconda parte è dedicata alle opere realizzate negli Stati Uniti. La mostra è una grande occasione per vedere le opere di Ernst in un'unica sede.

Il museo di New York ha organizzato una mostra di Max Ernst, un artista che ha trascorso la sua vita a viaggiare tra Parigi e New York. La mostra è curata da Robert Rauschenberg e Jasper Johns, due artisti che hanno lavorato con Ernst per molti anni. La mostra è divisa in due parti: la prima parte è dedicata alle opere di Ernst realizzate in Francia, la seconda parte è dedicata alle opere realizzate negli Stati Uniti. La mostra è una grande occasione per vedere le opere di Ernst in un'unica sede.

Max Ernst è nato a Brno, in Repubblica Ceca, nel 1891. Si trasferì a Parigi nel 1918, dove si unì al movimento Dada. Dopo la guerra, si trasferì a New York nel 1945, dove si unì al movimento Surrealista. Ernst è considerato uno dei più importanti artisti del XX secolo. Le sue opere sono caratterizzate dall'uso di tecniche miste, come il collage e il frottage. Le sue opere sono state acquistate da musei e collezionisti di tutto il mondo.

La mostra di New York è la prima mostra di Ernst negli Stati Uniti da oltre 20 anni. La mostra è curata da Robert Rauschenberg e Jasper Johns, due artisti che hanno lavorato con Ernst per molti anni. La mostra è divisa in due parti: la prima parte è dedicata alle opere di Ernst realizzate in Francia, la seconda parte è dedicata alle opere realizzate negli Stati Uniti. La mostra è una grande occasione per vedere le opere di Ernst in un'unica sede.

Il museo di New York ha organizzato una mostra di Max Ernst, un artista che ha trascorso la sua vita a viaggiare tra Parigi e New York. La mostra è curata da Robert Rauschenberg e Jasper Johns, due artisti che hanno lavorato con Ernst per molti anni. La mostra è divisa in due parti: la prima parte è dedicata alle opere di Ernst realizzate in Francia, la seconda parte è dedicata alle opere realizzate negli Stati Uniti. La mostra è una grande occasione per vedere le opere di Ernst in un'unica sede.

Max Ernst è nato a Brno, in Repubblica Ceca, nel 1891. Si trasferì a Parigi nel 1918, dove si unì al movimento Dada. Dopo la guerra, si trasferì a New York nel 1945, dove si unì al movimento Surrealista. Ernst è considerato uno dei più importanti artisti del XX secolo. Le sue opere sono caratterizzate dall'uso di tecniche miste, come il collage e il frottage. Le sue opere sono state acquistate da musei e collezionisti di tutto il mondo.

La mostra di New York è la prima mostra di Ernst negli Stati Uniti da oltre 20 anni. La mostra è curata da Robert Rauschenberg e Jasper Johns, due artisti che hanno lavorato con Ernst per molti anni. La mostra è divisa in due parti: la prima parte è dedicata alle opere di Ernst realizzate in Francia, la seconda parte è dedicata alle opere realizzate negli Stati Uniti. La mostra è una grande occasione per vedere le opere di Ernst in un'unica sede.

ULTRA[®] TECHNOLOGY

ARIOSFEA[®] HIGHTECH

- | | | | | |
|-----|---|---------------------------|---|----------------------------|
| 208 | + | Storage | + | Stoccaggio |
| 210 | + | Handling | + | Movimentazione |
| 212 | + | Cutting | + | Taglio |
| 216 | + | Holes | + | Fori |
| 217 | + | Floor laying | + | Posa pavimento |
| 222 | + | Wall covering | + | Rivestimento parete |
| 225 | + | Cleaning and maintainance | + | Pulizia e manutenzione |
| 227 | + | Table laying instructions | + | Tabella istruzioni di posa |
| 228 | + | Suggested adhesives | + | Adesivi suggeriti |
| 231 | + | Kit Ultra Case | + | Kit Ultra Case |
| 239 | + | Technical features | + | Caratteristiche tecniche |

END



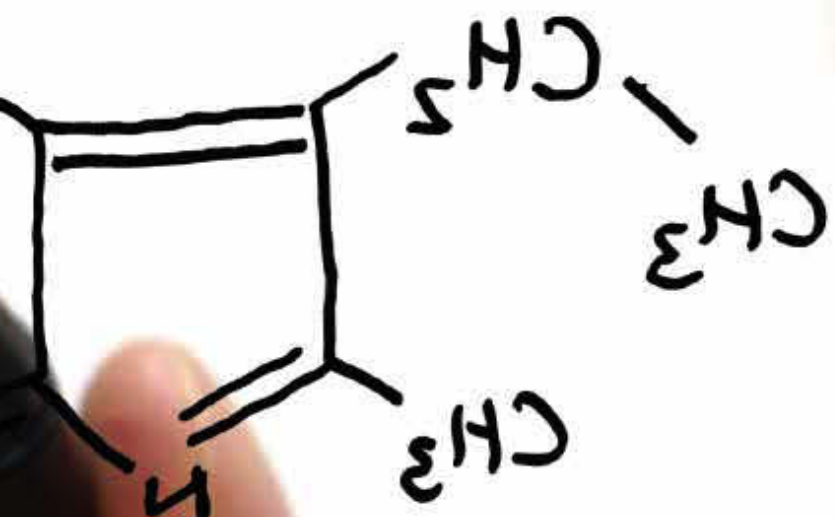
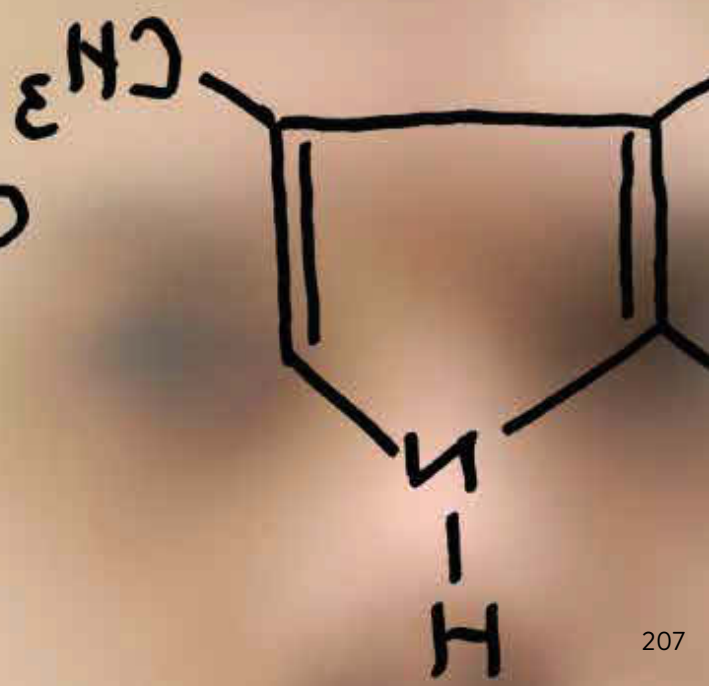
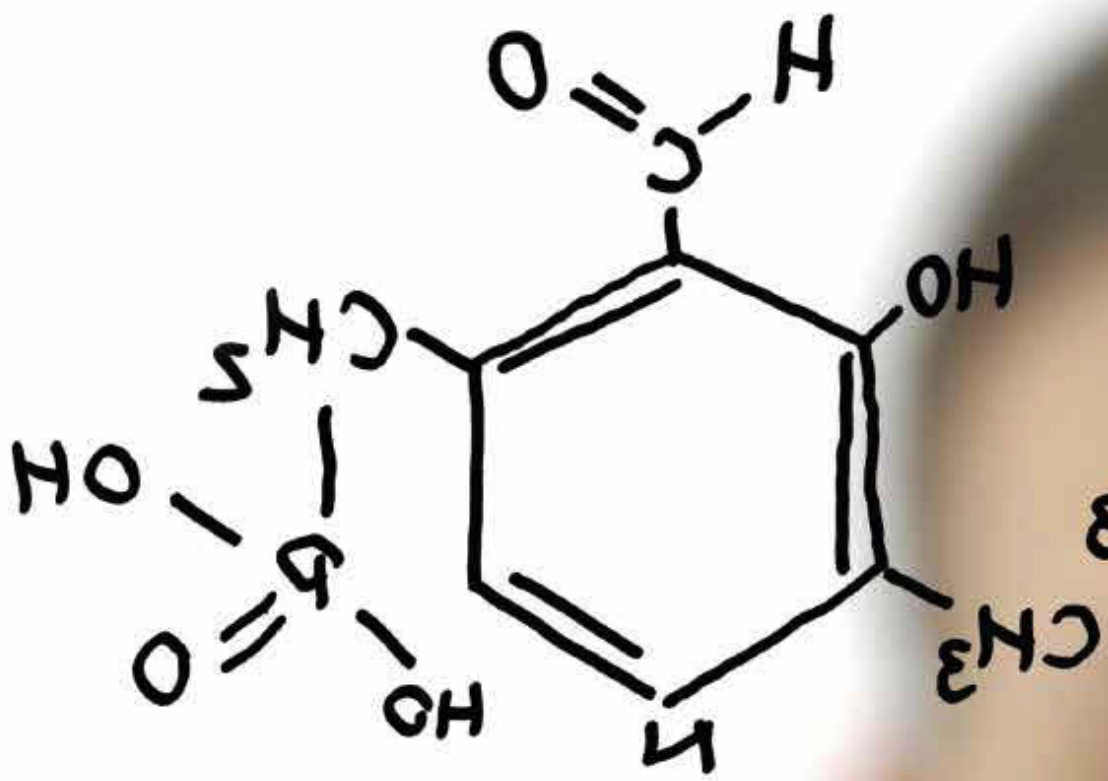

Handwritten text: $5.5 \cdot 10^4$

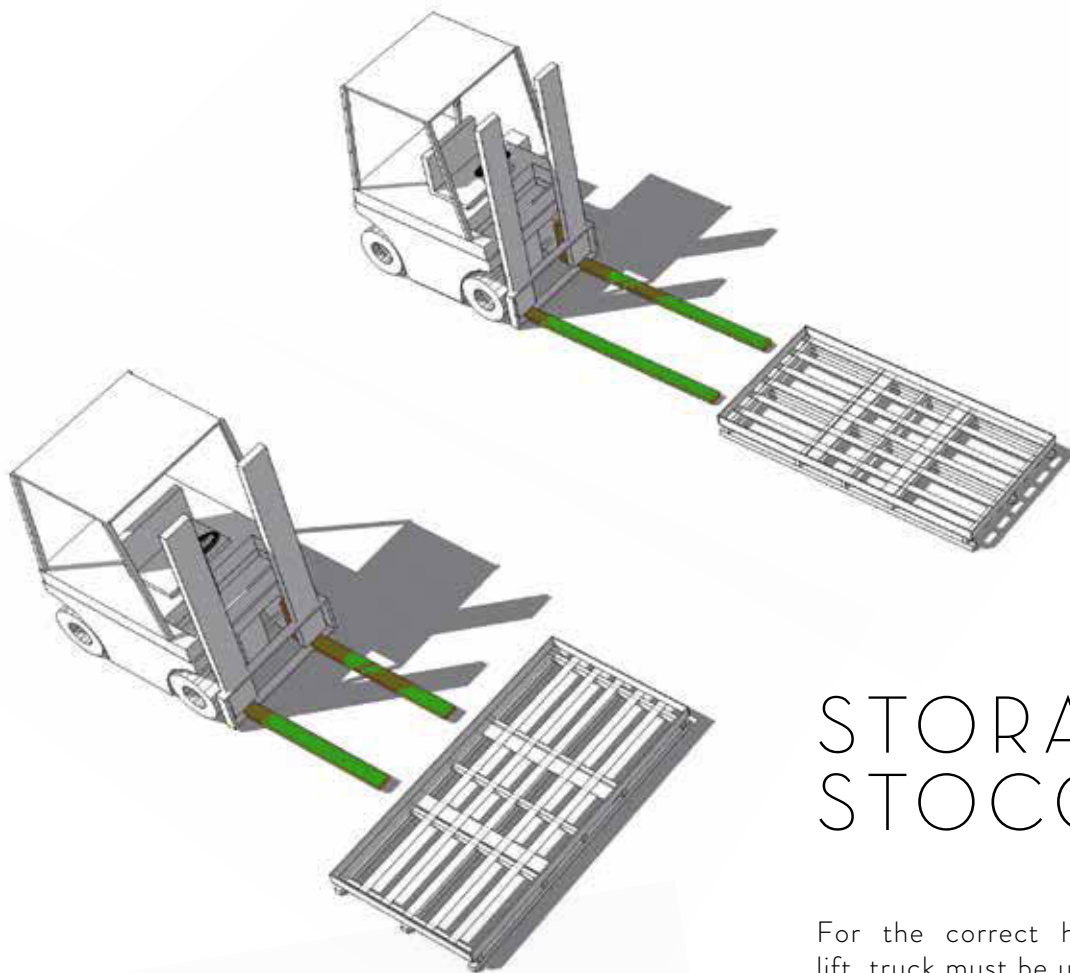

STORAGE STOCCAGGIO

For the correct handling of the pallets, a fork lift truck must be used, at least 1.5 m long, with the forks positioned in the largest width position.

Under normal conditions, the forks are positioned in the middle of the long side of the pallet, as they must grip the whole depth of the pallet.

To allow the extraction of the slabs easily and safely, it is recommended to position the pallets in a suitable area where the lift truck can be moved around all sides of the pallet.

Per una corretta movimentazione dei pallet è necessario l'utilizzo di un carrello elevatore a forche con una lunghezza di almeno 1,5 mt e con posizionamento delle stesse nella posizione di massima larghezza.

In condizioni normali, le forche vanno posizionate al centro del lato lungo del pallet, in quanto le stesse devono far presa su tutta la profondità del pallet.

Per permettere l'estrazione delle lastre con facilità e sicurezza, si consiglia di posizionare i pallet in un'area adeguata in cui sia possibile muoversi con il carrello elevatore attorno ad ogni lato del pallet.

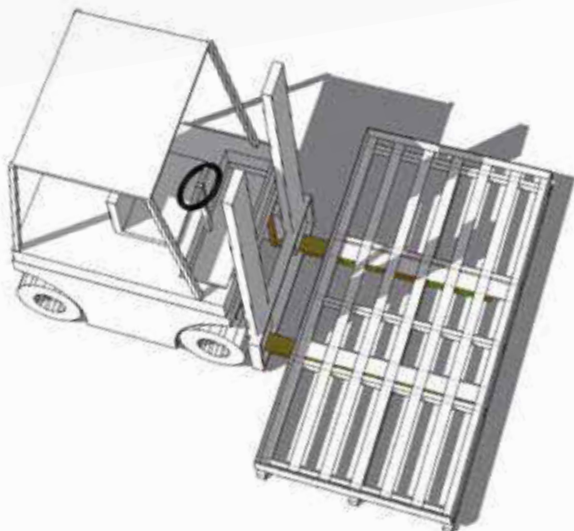
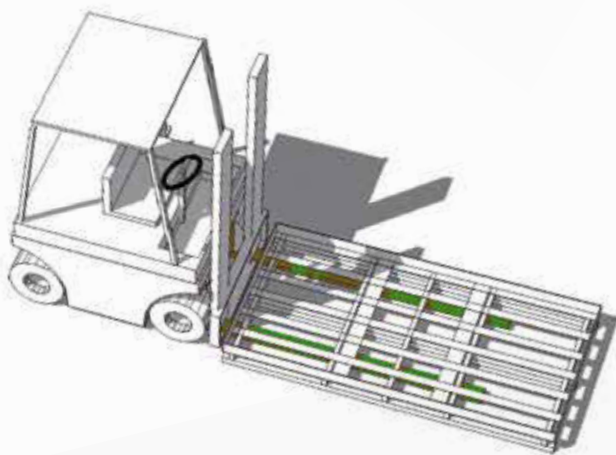

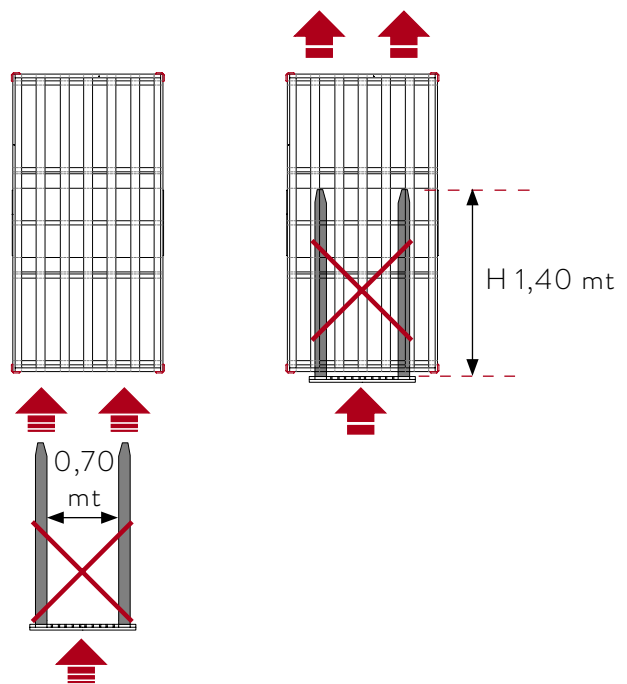
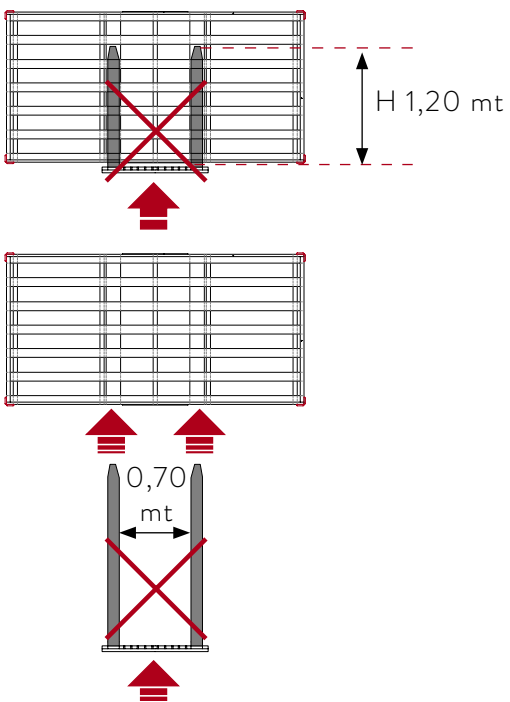
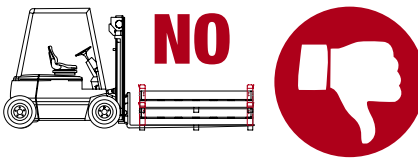
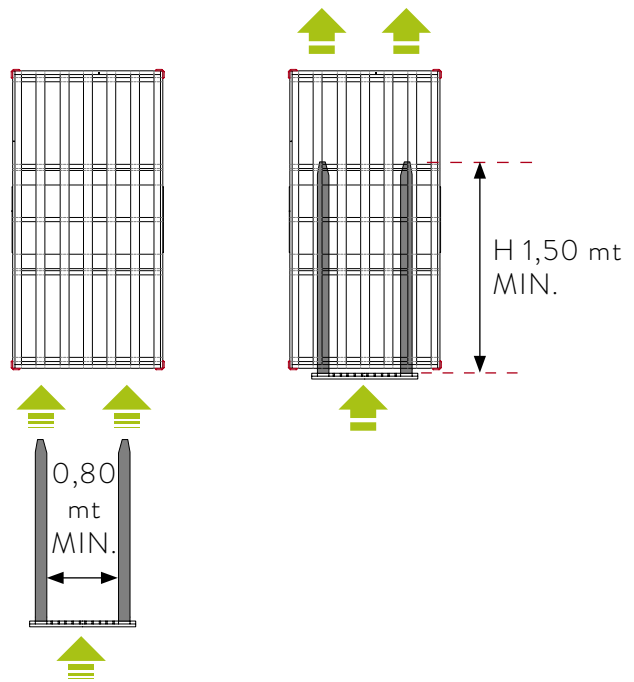
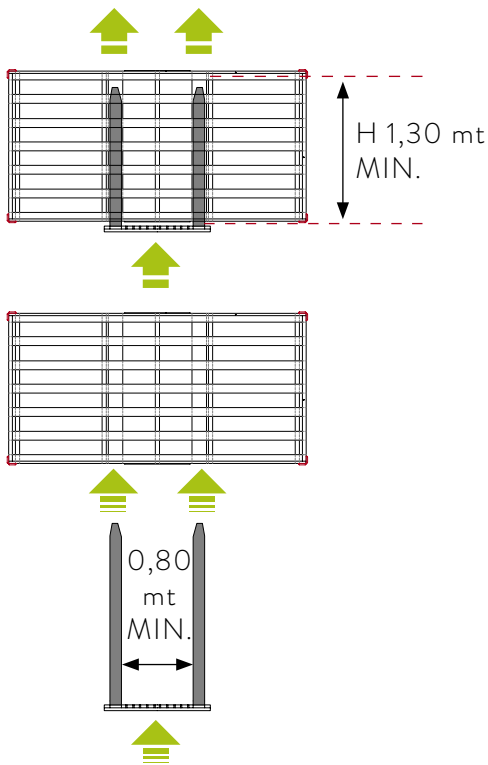
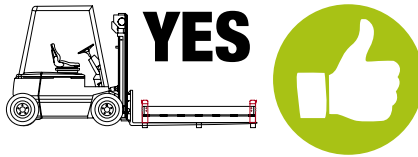

HANDLING MOVIMENTAZIONE

For manual handling and subsequent laying of the “ULTRA” slabs, in order to guarantee the operators’ safety and the integrity of the slabs, it is strongly recommended to use a handling frame with suction cups and a truck for transport, available upon request, particularly suitable for large dimension “ULTRA” formats (e.g. 320x160 cm – 300x150 cm – 150x150 cm) whereas on smaller “ULTRA” formats (e.g. 100x100 cm) two double suction cups are sufficient.

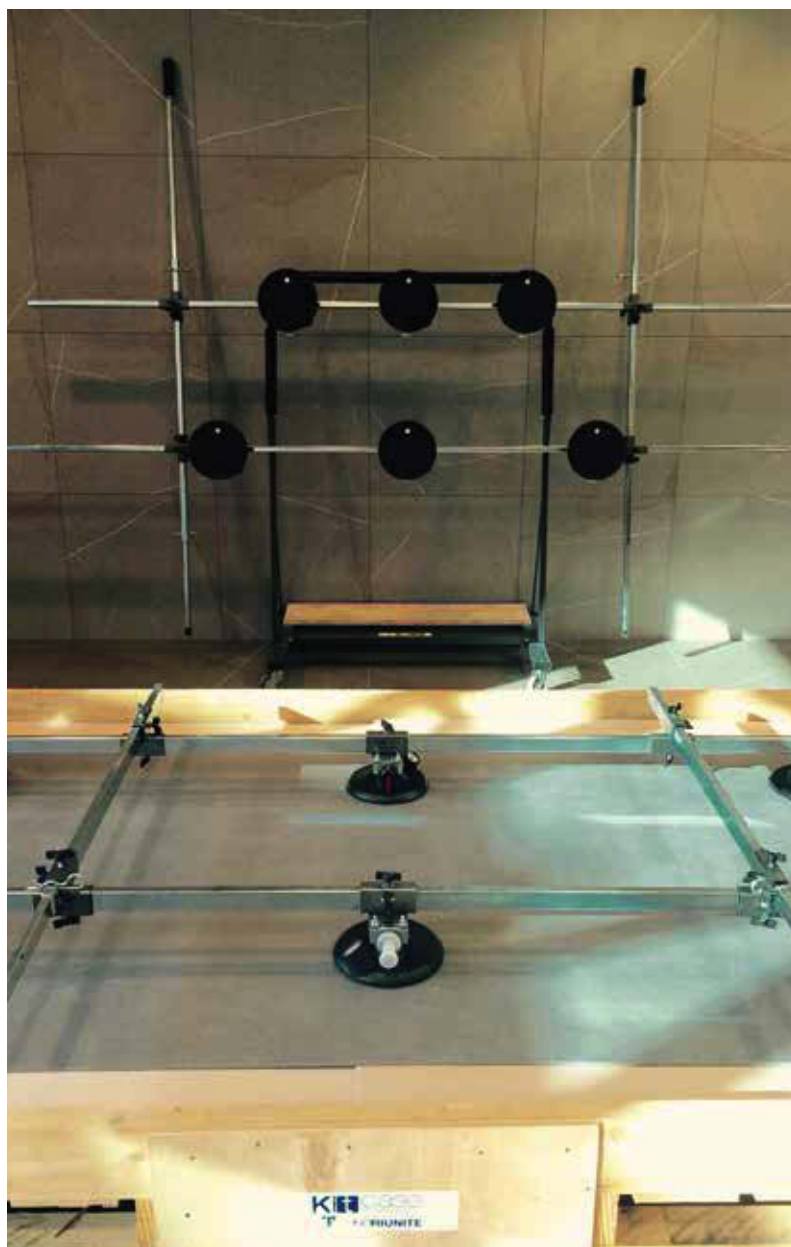

Per la movimentazione manuale e la successiva posa in opera delle lastre “ULTRA”, al fine di garantire sicurezza per gli operatori e integrità delle lastre, è vivamente consigliato l'utilizzo del telaio di movimentazione con ventose di sicurezza, dotato di carrello per il trasporto, disponibili su richiesta, indicato in particolare per i formati “ULTRA” di dimensioni significative (es. 320x160 - 300x150 cm - 150x150 cm) mentre su formati “ULTRA” inferiori (es. 100x100 cm) può essere sufficiente l'utilizzo di due biventose.



INSTRUMENTS REQUIRED

The instruments for lifting and handling the slabs can be chosen according to the size of the slab and the activities to be performed on the site, in particular:

- + Fork lift truck with forks 2.5 m long.
- + Handling frame with suction cups and a transport truck with wheels.
- + Double suction cups for handling slabs with format up to 150x75 cm.

PROCESSING STAGES:

- + Remove the cover from the case.
- + Position the handling frame with suction cups on the slab, and make sure that the cups adhere to it perfectly, checking that the arrow inside the manometer is beyond the red area.
- + For horizontal handling (on the surface), use the handling frame with suction cups, put the slab into a vertical position and position it on the transport truck with wheels.

STRUMENTAZIONE NECESSARIA

Gli strumenti per il sollevamento e la movimentazione delle lastre sono da scegliere in funzione della dimensione della lastra e delle attività da svolgere in cantiere, in particolare:

- + Carrello elevatore con forche lunghe 2,5 mt.
- + Telaio di movimentazione con ventose di sicurezza dotato di carrello per il trasporto con ruote
- + Biventose per la movimentazione di lastre di formato fino a 100x100 cm.

FASI DI LAVORAZIONE:

- + Rimuovere la copertura dalla cassa.
- + Posizionare sulla lastra telaio di movimentazione con ventose di sicurezza, accertarsi che le stesse aderiscano perfettamente, verificando che la freccia all'interno del manometro sia oltre la zona rossa.
- + Per il trasporto orizzontale (sul piano), avvalendosi del telaio di movimentazione con ventose di sicurezza, portare in posizione verticale la lastra e posizionarla sul carrello per il trasporto con ruote.

CUTTING / TAGLIO

- + “ULTRA” can be easily processed by using some simple tools.
- + It is recommended to process the slabs on a flat work surface.
- + It is recommended to perform the cutting operations with at least two operators. One operator is sufficient for making the holes.

INSTRUMENTS REQUIRED

Depending on the type of cut and process to be applied to the slab, the recommended types of tools are listed below:

- + Handling frame with suction cups with a transport truck with wheels or double suction cups.
- + Cutting guide with cutting carriage for linear or diagonal cuts of up to 320 cm.
- + Cutting pliers.
- + Diamond buffer.
- + Wet core bits
- + Angle grinder with diamond blade.

Also see KIT ULTRA CASE (page 231)

- + “ULTRA” permette di essere lavorato con grande facilità tramite l'utilizzo di alcuni semplici strumenti.
- + Si consiglia di effettuare le lavorazioni su una superficie piana di lavoro
- + Si consiglia di effettuare le lavorazioni di taglio in almeno due operatori, per i fori è sufficiente l'impiego di un solo operatore .

STRUMENTAZIONE NECESSARIA

A seconda del tipo di taglio e lavorazione da effettuare sulla lastra, vengono elencate di seguito le attrezzature consigliate:

- + Telaio di movimentazione con ventose di sicurezza dotato di carrello per il trasporto con ruote o biventosa.
- + Guida da taglio con carrello incisore per tagli fino a 320cm lineari e diagonali
- + Pinza troncatrice.
- + Tampone diamantato.
- + Foretti diamantati per foratura ad umido
- + Smerigliatrice angolare con disco diamantato.

Vedi anche KIT ULTRA CASE (pag. 231)

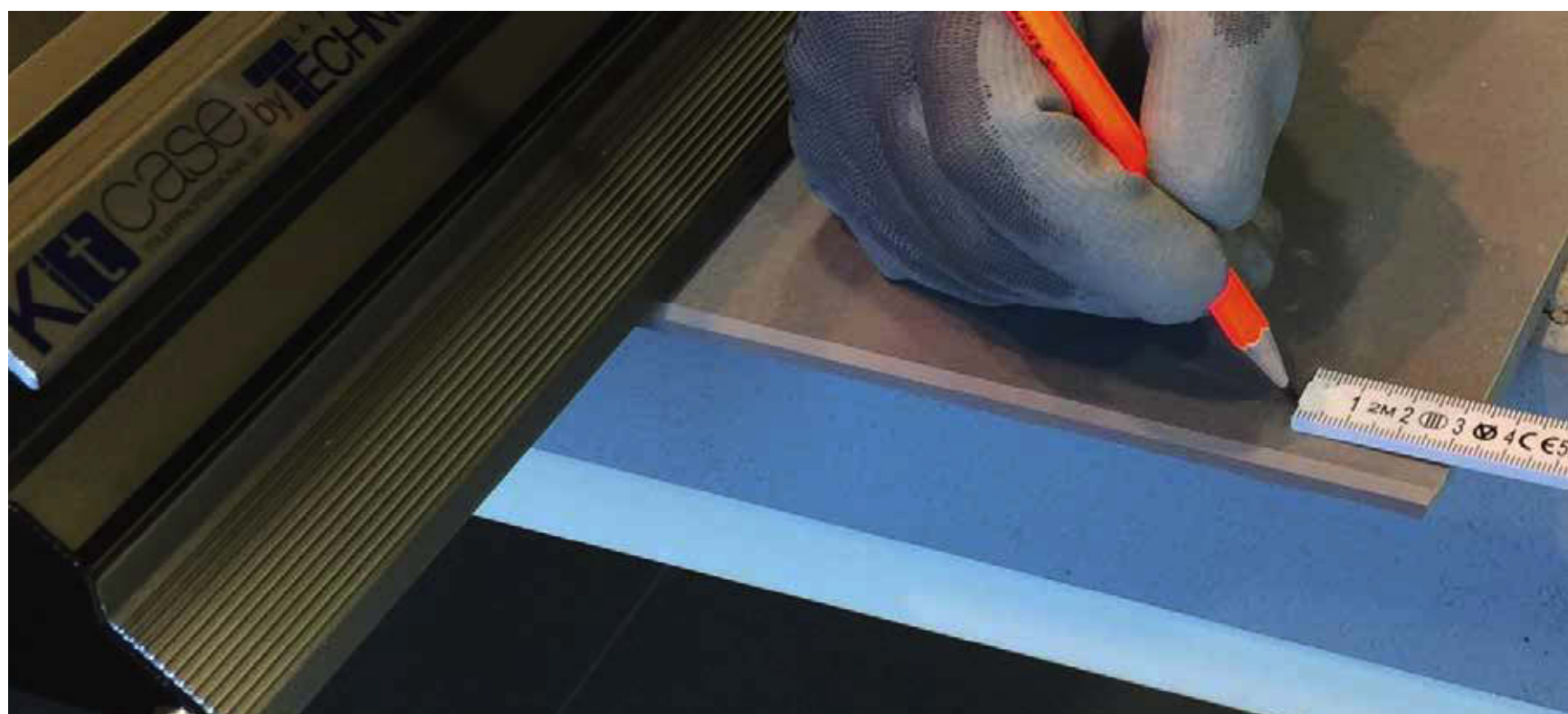



MARKING:

Linear cuts

Mark the dimension of the portion to be removed at both ends of the slab.

Position the cutting guide with cutting carriage so that the roller on the cutting guide coincides with the lines marked on the slab. Lock the cutting guide with the cutting carriage in place using the suction cups.

SCORING:

To guarantee correct scoring, the pressure and movement of the cutting carriage must be constant along the whole length of the cut.

- + Score one end of the slab by 5 cm pushing the cutting carriage towards the edge of the slab.
- + Repeat on the other end.
- + Complete the scoring up to the opposite edge of the slab

TRACCIATURA:

Tagli lineari

Segnare alle due estremità della lastra, la dimensione della porzione da asportare.

Posizionare la guida da taglio con carrello incisore in modo tale che la rotella posta nel carrello incisore sia posta sopra alla linea sopra segnata. Bloccare la guida da taglio con carrello incisore per mezzo delle ventose poste sulla stessa.

INCISIONE:

Per garantire una corretta incisione la pressione e l'avanzamento del carrello d'incisione devono essere costanti per tutta la lunghezza del taglio.

- + Incidere per 5 cm una estremità della lastra spingendo il carrello d'incisione verso il bordo della lastra.
- + Ripetere nell'estremità opposta.
- + Completare l'incisione unendo i due bordi lastra opposti

CUTTING OFF:

- + Using the cutting guide move the slab until the scoring line protrudes by 5/10 cm from the work surface.
- + Release the cutting guide from the suction cups and move it towards the middle of the slab.
- + Start the cutting off process by positioning the cutting pliers in line with the line scored on the slab. Exert light and progressive pressure until you notice that the cutting off process has begun.
- + Go to the opposite side and position the cutting pliers in line with the line scored on the slab. Exert light and progressive pressure until you notice that the cutting off process has begun.
- + To complete the cutting off process, with the cutting pliers and exert progressive pressure downwards all along the line scored on the slab.

TRONCATURA:

- + Per mezzo della guida di taglio traslare la lastra fino a che la linea di incisione sporga 5/10 cm dal piano di lavoro.
- + Liberare dalle ventose la guida di taglio e spostarla verso il centro della lastra.
- + Iniziare la troncatura posizionando la pinza troncatrice in corrispondenza della linea incisa sulla lastra. Esercitare una pressione leggera e progressiva fino a che si noti l'inizio troncatura.
- + Portarsi sul bordo opposto e posizionare la pinza troncatrice in corrispondenza della linea incisa sulla lastra. Esercitare una pressione leggera e progressiva fino a che si noti l'inizio troncatura.
- + Per completare la troncatura, con la pinza troncatrice esercitare una leggera pressione progressiva verso il basso, lungo tutta la linea incisa sulla lastra.



THE FINISHING of the edges on the cut side, if left visible, must be carried out using the special diamond buffer, or alternatively using appropriate resinous diamond discs.

LA FINITURA dei bordi del lato tagliato, se lasciati a vista, deve essere effettuata utilizzando l'apposito tampone diamantato, o in alternativa mediante l'uso degli appositi dischi resinosi diamantati.



L-SHAPED CUTS / SQUARE CUTS / CUT-OUT

- + Mark the portion to be removed on the slab.
- + Make $\varnothing 7/8$ mm holes, using wet core diamond bits corresponding to the point where the lines traced on the slab meet.
- + With an angle grinder equipped with a diamond blade, join the 4 holes.

RECTANGULAR HOLES

- + Mark the sides of the portion to be removed on the slab.
- + Make holes of $\varnothing 7/8$ mm, using wet core diamond bits corresponding to the 4 corners.
- + Using an angle grinder equipped with a diamond blade join the 4 holes.



TAGLI AD L / TAGLI IN QUADRO / SCASSI

- + Tracciare sulla lastra la porzione da asportare.
- + Eseguire fori di $\varnothing 7/8$ mm, utilizzando i foretti diamantati per foratura ad umido in corrispondenza del punto di congiunzione delle linee tracciate sulla lastra.
- + Con smerigliatrice angolare equipaggiata con disco diamantato congiungere i 4 fori.

FORI RETTANGOLARI

- + Tracciare sulla lastra i lati della porzione da asportare.
- + Eseguire fori di $\varnothing 7/8$ mm, utilizzando i foretti diamantati per foratura ad umido in corrispondenza dei 4 angoli.
- + Con smerigliatrice angolare equipaggiata con disco diamantato congiungere i 4 fori.



HOLES FORI



INSTRUMENTS REQUIRED

Depending on the type of hole and process to be applied to the slab, it is recommended to use the following instruments:

- + Handling frame with suction cups with a transport truck with wheels or double suction cups.
- + Drill/Screwdriver.
- + Wet diamond core bits (cup wheel cutters).
- + Angle grinder with diamond blade.

STRUMENTAZIONE NECESSARIA

A seconda del tipo di foro e lavorazione da effettuare sulla lastra, queste sono le attrezzature che si consiglia di utilizzare:

- + Telaio di movimentazione con ventose di sicurezza dotato di carrello per il trasporto con ruote o biventosa.
- + Trapano/Avvitatore.
- + Foretti diamantati per foratura a umido (frese a tazza).
- + Smerigliatrice angolare con disco diamantato.



ROUND HOLES

- + Position the “ULTRA” slab on a solid, non-slip surface (e.g. wood or concrete). Spray water onto the area where the hole is to be made.
- + Start to make a hole at an angle of 75°-85° and penetrate into the slab with a depth of about 1-2 mm.
- + Keep the drill/screwdriver at a 90° angle and make circular movements with an angle of about 5°-10°. Do not exert too much pressure. Do not push straight downwards. Make sure there is enough water to wet the cutter.
- + Clean up the scraps once the hole has been made.

FORI TONDI

- + Posizionare la lastra “ULTRA” su un supporto solido e non scivoloso (es. legno o cemento). Spruzzare acqua nell’area dove verrà praticato il foro.
- + Iniziare ad eseguire il foro ad un angolo di 75°-85° e penetrare nella lastra per circa 1-2 mm di profondità.
- + Mantenere il trapano/avvitatore ad un angolo di 90° ed effettuare movimenti circolari con un angolo di circa 5°-10°. Non esercitare troppa pressione. Non spingere dritti verso il basso. Assicurarsi che l’acqua sia sufficiente per inumidire la fresa.
- + Pulire dai detriti una volta effettuato il foro.

FLOOR LAYING / POSA PAVIMENTO

DESCRIPTION AND TECHNICAL FEATURES

Laying “ULTRA” slabs require similar laying conditions to those required for traditional format slabs. “ULTRA” requires the adhesive to be applied both on the setting bed and on the back of the slab.

“ULTRA” slabs for flooring require the following conditions:

- + Dry and seasoned.
- + Planar and free of cracks.
- + Cleaning of dust, debris and removal of concrete lumps.
- + Compact and resistant.
- + The substrate must be uniform and have already completed the shrinkage of maturation.

DESCRIZIONE E CARATTERISTICHE TECNICHE

La posa delle lastre “ULTRA” richiede condizioni di posa simili a quelle richieste per lastre in formato tradizionale. “ULTRA” richiede l’utilizzo della tecnica a doppia spalmatura; ovvero il collante deve essere applicato sia sul fondo di posa che sul retro della lastra. Per la posa a pavimento, “ULTRA” richiede le migliori condizioni di sottofondo:

- + Asciutto e stagionato.
- + Planare e privo di fessurazioni.
- + Pulizia da polvere, detriti ed eliminazione di grumi di cemento.
- + Compatto e resistente.
- + Il fondo di posa deve essere omogeneo e avere già compiuto il ritiro igrometrico di maturazione.



217

INSTRUMENTS REQUIRED

- + Cement-based powder adhesive for full spread, class “C2E according to EN 12004 and S1 according to EN 12002 standards”.
- + 3x3 mm square toothed trowel for the back of the slab
- + 10 x 10 mm square toothed trowel for the slab.
- + Handling frame with suction cups with a transport truck with wheels or double suction cups.
- + Non-bounce plastic mallet 170x370 mm.
- + Levelling system: puller/leveller

STRUMENTAZIONE NECESSARIA

- + Collante in polvere a base cementizia a letto pieno di classe “C2E secondo le normative EN 12004 e S1 secondo la normativa EN 12002”.
- + Spatola a denti quadri 3x3 mm per il retro lastra
- + Spatola a denti quadri 10x10 mm per la lastra
- + Telaio di movimentazione con ventose di sicurezza dotato di carrello per il trasporto con ruote o biventosa.
- + Battitore in plastica antirimbazzo 170x370 mm.
- + Sistema livellante a tirate / livellatore

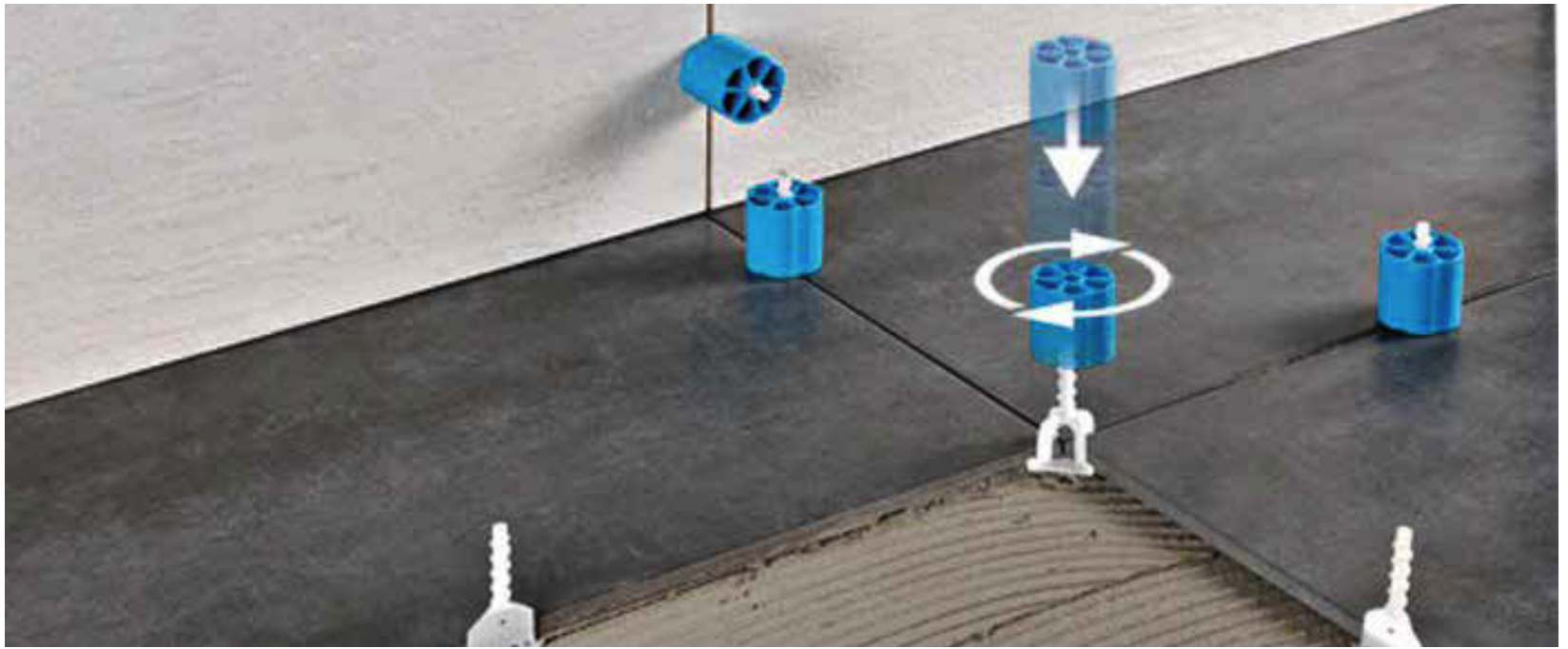

BONDING TO THE FLOOR

- + Ensure that the surface to be covered is solid, flat and free from dust and oil/grease.
- + Use the adhesives described mixed according to the specifications indicated in the technical data sheet of the chosen adhesive.
- + Spread the adhesive onto the surface to be covered with a 10 x 10 mm square toothed trowel across an area of 5/10 cm more than the dimensions of the slab.
- + Make the last spread of adhesive taking care that the direction of the lines is always only in one direction, vertical or horizontal, thus avoiding intersections.
- + With the slab fixed in a vertical position on the handling frame with suction cups placed over the wheeled transport truck, spread the adhesive onto the back of the slab with a 3x3 mm square toothed trowel.
- + Using the handling frame with suction cups, bring the slab into a horizontal position and lay it.
- + To guarantee uniform bonding of the slab, the special 170x370 mm non-bounce plastic mallet must be used, tapping from the middle towards the edges so as to remove any air pockets between the back of the slab, the adhesive and the surface to be tiled. Do not use hammers.
- + Use the puller/leveller levelling system.

INCOLLAGGIO A PAVIMENTO

- + Assicurarsi che la superficie da rivestire sia consistente, planare, priva di polvere e unti/grassi.
- + Utilizzare i collanti descritti miscelati in base alle specifiche indicate nella scheda tecnica del collante prescelto.
- + Stendere il collante sulla superficie da rivestire con spatola a denti quadri 10x10 mm per per un'area superiore di 5/10 cm rispetto alle dimensioni della lastra.
- + Realizzare l'ultima stesura del collante avendo cura che l'andamento delle righe sia sempre e solo in un unico verso, verticale od orizzontale, evitando quindi gli incroci per favorire l'espulsione dell'aria dal centro della lastra.
- + Con la lastra in posizione verticale fissata al telaio di movimentazione con ventose di sicurezza posato sopra al carrello per il trasporto con ruote, stendere il collante sul retro della lastra con spatola a denti quadri 3x3 mm.
- + Con l'utilizzo del telaio di movimentazione con ventose di sicurezza portare la lastra in posizione orizzontale e posarla.
- + Per garantire l'incollaggio uniforme della lastra, si deve utilizzare apposito battitore in plastica anti-rimbalzo 170x370 mm, effettuando una battitura dal centro verso i bordi per eliminare eventuali sacche d'aria fra il retro della lastra, il collante ed il fondo di posa. Non utilizzare martelli.
- + Utilizzo di sistema livellante a tirate / livellatore.

LEVELING SYSTEM WITH LEVELER / ROTATING POMMEL

is a revolutionary and innovative leveling system when laying medium and large materials with a thickness between 2 and 40 mm. The patented system is made of 2 elements:

- + A leveling base (1-2-3 mm size) with spaced notches that allow spacing/separating/ joining floors of any type and material in a way that is: linear, cross and half cross with joints to be chosen between 1 mm, 2 mm and 3 mm.
- + The threaded stem is attached perpendicularly to the base in a way that allows for easy adjustment with turns of the cap during installation.

Removal of the cap and Stem after the materials are set is made easy with strategically placed breakage points that release with either increased pressure by turning the cap or by kicking the cap in the direction of the joint.

One cap fits all threaded stems and can be reused an infinite amount of times for big cost savings. The new PPLS (patented) system assists in the reduction or elimination of ledging and lippage in the installation of various types of materials that are applied to floors or walls with mortar including: Large Format Tile, Natural Stone, Thin Profile Tile and many others.

Choose the desired type of Leveler (spacers) based on the requested joints and joining:

- + 1 mm Linear Version
- + 1 mm Linear, Cross and Half Cross Version
- + 2 mm Linear, Cross and Half Cross Version
- + 3 mm Linear, Cross and Half Cross Version

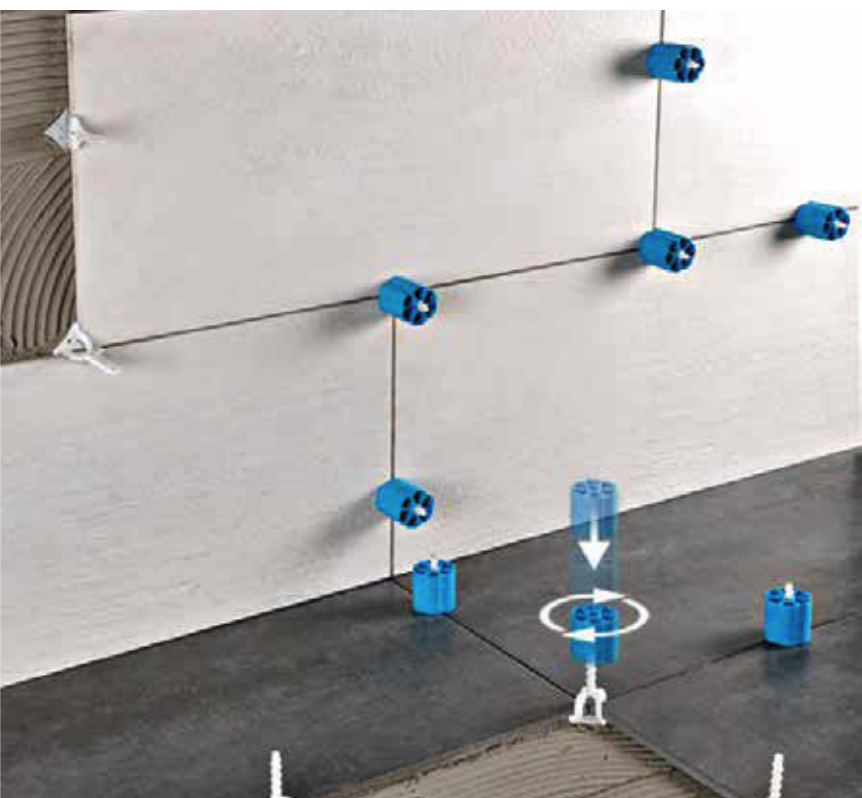

SISTEMA LIVELLANTE A TIRANTE / LIVELLATORE

è un sistema rivoluzionario ed innovativo di livellamento nella posa di materiali di medio e grande formato di spessore compreso tra 2 e 40 mm. Il sistema è composto da 2 elementi:

- + Una base livellatore (da 1-2-3 mm) con rilievi distanziali che permettono di distanziare/separare/accostare pavimenti di qualsiasi genere e materiale in modo: lineare, a croce e a mezza croce con fughe a scelta da 1 mm, 2 mm e 3 mm.
- + Uno stelo filettato centralmente fissato ortogonalmente/perpendicolarmente alla base con diversi punti a rottura facilitata permette, alla manopola (tirante) di serraggio di regolare la pressione esercitata sulla superficie e di livellare la pavimentazione e/o rivestimento in modo uniforme.

Al termine della posa e del periodo necessario per l'aggrappaggio/incollaggio con il pavimento/rivestimento è sufficiente calciare il Tirante nella direzione della fuga. Il tirante è unico per tutte le altezze e modelli ed è riutilizzabile infinite volte. Il nuovo sistema ha lo scopo di evitare la formazione di dislivelli, "denti", tra le lastre/formati di ceramica, marmo, pietre naturali, bassi spessori slim per una perfetta planarità del Pavimento e/o Rivestimento.

Scegliere il tipo di Livellatore desiderato in base alle fughe e accostamento richiesto:

- + Versione Lineare da 1 mm
- + Versione Lineare, a Croce e Mezza Croce da 1 mm
- + Versione Lineare, a Croce e Mezza Croce da 2 mm
- + Versione Lineare, a Croce e Mezza Croce da 3 mm



SLLL 1
SLLL 2
SLLL 3



SLLT 1
SLLT 2
SLLT 3



SLLC 1
SLLC 2
SLLC 3



SLLT

APPLICATION OF THE LEVELLING SYSTEM

POSITIONING THE BASE CLIP:

- + Spread the adhesive on the support.
- + Position the selected levelling base, cross, half cross or linear, under the slab.
- + Depending on the format of the slab, position one or more linear supports for each side of the slab.
- + Position the next slab.

INSERTING THE PULLER/POMMEL FOR ROTATIVE TIGHTENING:

- + Insert the puller/pommel for rotative tightening in the threaded slot of the leveller base.
- + Rotate clockwise to level the paving slab/covering.

REMOVING THE PULLER/POMMEL FOR ROTATIVE TIGHTENING:

- + Once the adhesive has dried, the puller/pommel for rotative tightening can be separated from the leveller base by tapping with your foot in line with the joint.

APPLICAZIONE DEL SISTEMA LIVELLANTE

POSIZIONAMENTO DELLA BASE:

- + Stendere la colla sul supporto
- + Posizionare la Base livellatore scelta, a croce, mezza croce o lineare sotto la lastra.
- + In funzione del formato della lastra posizionare uno o più supporti lineare per ogni lato della lastra.
- + Posizionare la successiva lastra.

INSERIMENTO TIRANTE/POMELLO DI SERRAGLIO ROTATIVO:

- + Inserire il Tirante/Pomello di serraglio rotativo nello stelo filettato della base livellatore.
- + Ruotare in senso orario fino a livellare il pavimento/ rivestimento.

ELIMINAZIONE TIRANTE/POMELLO DI SERRAGLIO ROTATIVO:

- + A maturazione del collante avvenuta, il Tirante/Pomello di serraglio rotativo si separa dalla base livellatore calciando con il piede nella direzione della linea di fuga.



DUAL FITTING SYSTEM is an innovative dry system for laying large floor slabs (minimum recommended format 60x60 cm, thickness 1 cm). The DUAL FITTING SYSTEM provides adhesion between the slab and the support surface using a special blanket covered by a special adhesive applied on both sides.

The DUAL FITTING SYSTEM does not require the use of traditional cement-based adhesives for laying the slabs, hence it is possible to walk on the finished floor immediately since the drying times and dust produced by the operations are both eliminated. This exceptional characteristic makes it particularly suitable for application in environments where laying must be carried out quickly and with low environmental impact. 15 m² (1 rolls of blanket).

DUAL FITTING SYSTEM è un sistema innovativo a secco per realizzare la posa in opera a pavimento di lastre di importanti dimensioni (formato minimo consigliato 60x60 cm, spessore 1 cm).

Il DUAL FITTING SYSTEM prevede che l'adesione tra la lastra ed il fondo di posa venga creata impiegando un apposito materassino rivestito da adesivo acrilico posto su entrambi i lati.

L'utilizzo di DUAL FITTING SYSTEM non prevede l'impiego dei tradizionali collanti a base cementizia per la posa di lastre, permettendo il calpestio immediato del pavimento, annullando i tempi di asciugatura ed eliminando le polveri prodotte dalle lavorazioni. Questa eccezionale caratteristica lo rende particolarmente adatto all'applicazione in ambienti in cui la posa deve essere compiuta rapidamente ad impatto ambientale nullo. 15 mq (1 Rotoli) di materassino.

FOR LAYING SLABS USING THE DUAL FITTING SYSTEM similar support surface conditions to those needed for laying with adhesive are required. The surface can be: Tile floors, marble or wood pre-existing; cement screed or concrete; resin floor, linoleum or PVC uniform.

As long as the characteristics described below exist:

- + Check the suitability of the support surface in advance: The surface must be stable, must have already undergone the drying shrinkage process, must be resistant to loads and suitable for the intended use, must be dry, clean and free from loose parts (dust, oil grease, wax, paint and anything else that could affect adhesion), free from cracks and perfectly flat.
- + Laying: Remove the white protective film based on the slab dimensions, then lay the slab, without exerting pressure, according to the required layout. Once verified the correct position of the slab, apply pressure on it, manually or with a special tool. Continue to position the other slabs, making sure they are spaced with the spacers (provided in the kit). Once the slabs have been laid, it is possible to walk on top of them immediately after installation. The part of the blanket without the protective film must not be stepped on or soiled prior to application of the slab. Once the laying process is completed, apply the elastomeric grout in the joints with the acetic silicone sealant.

The accidental bumps and impact can cause damage.

LA POSA DELLE LASTRE CON DUAL FITTING SYSTEM richiede condizioni del sottofondo di posa simili a quelle necessarie per la posa a colla. Il fondo può essere sia un massetto, un pavimento in gres preesistente o un pavimento in legno, purché presenti le caratteristiche sotto descritte: Verificare preventivamente l'idoneità del fondo di posa:

- + il fondo deve essere stabile, avere già compiuto il ritiro igrometrico di maturazione, la resistenza deve essere idonea ai carichi e alla destinazione d'uso prevista, asciutto, pulito, privo di parti asportabili (polvere, grassi oli, cere, vernici e quanto altro possa pregiudicarne l'adesione), privo di fessurazioni e perfettamente planare. Eventuali dislivelli di planarità devono essere colmati con idonei prodotti di rasatura.
- + Realizzazione della posa: Posizionare il materassino bi-adesivo sul fondo di posa da rivestire, avendo cura di rivolgere la pellicola protettiva verso l'alto. Il materassino deve aderire perfettamente al fondo di posa affinché non si creino bolle d'aria. Asportare la pellicola protettiva in base alle dimensioni della lastra, successivamente posare la lastra secondo il layout da riprodurre. Procedere posizionando le successive lastre provvedendo a distanziarle con le crocette di plastica (da 2mm a 3 mm). Le lastre posate sono immediatamente calpestabili. Una volta completata la posa, eseguire la stuccatura elastomerica delle fughe col sigillante in cartuccia.

Gli urti accidentali possono causare rotture.

MATTRESS MATERASSINO	THICKNESS SPESSORE	WEIGHT PER ROLL PESO A ROTOLO	ROLL SIZE DIMENSIONI ROTOLO	DENSITY DENSITÀ
Chemical reticular polyethylene with adhesive on both sides	3 mm	3,4 kg	Width 0.75 m. Length 20 m. Area 15 sq.m.	Appr. 30 g/m ³
Polietilene chimico reticolato adesivizzato su entrambi i lati	3 mm	3,4 kg	Larghezza 0,75 mt Lunghezza 20 m Superficie 15 mq	30 g/m ³ circa



WALL COVERING / RIVESTIMENTO PARETE

BONDING TO THE WALL

- + Ensure that the surface to be covered is solid, flat and free from dust.
- + Use powder adhesive with a cement base in a full bed of class C2E according to standard EN 12004 and S1 according to standard EN 12002”.
- + Spread the adhesive onto the surface to be covered with a 10 x 10 mm square toothed trowel across an area of 5/10 cm more than the dimensions of the slab.
- + Make the last spread of adhesive taking care that the direction of the lines is always only in one direction, vertical or horizontal, thus avoiding intersections to expel the air from the middle of the slab.
- + With the slab fixed in a vertical position on the handling frame with suction cups placed over the wheeled transport truck, spread the adhesive onto the back of the slab with a 3x3 mm square toothed trowel.
- + Using the handling frame with suction cups, bring the slab into a vertical position and lay it.
- + To guarantee uniform bonding of the slab, the special 170x370 mm non-bounce plastic mallet must be used, tapping from the middle towards the edges so as to remove any air. Do not use hammers
- + Use the puller/leveller levelling system
- + Before proceeding to fixing the next slab, it is possible to fix the concealed mechanical security hook to the wall with appropriate nails for gas nail guns. So as to guarantee the quality of the fixing for the mechanical hook it is recommended to use the correct gas nailgun so as to guarantee a constant application of energy.

INCOLLAGGIO A PARETE

- + Assicurarsi che la superficie da rivestire sia consistente, planare, priva di polvere.
- + Collante in polvere a base cementizia a letto pieno di classe “C2E secondo le normative EN 12004 e S1 secondo la normativa EN 12002”.
- + Stendere il collante sulla superficie da rivestire con spatola a denti quadri 10x10 mm per un’area superiore di 5/10 cm rispetto alle dimensioni della lastra.
- + Realizzare l’ultima stesura del collante avendo cura che l’andamento delle righe sia sempre e solo in un unico verso, verticale od orizzontale, evitando quindi gli incroci per favorire l’espulsione dell’aria dal centro della lastra.
- + Con la lastra in posizione verticale fissata al telaio di movimentazione con ventose di sicurezza posato sopra al carrello per il trasporto con ruote , stendere il collante sul retro della lastra con spatola a denti quadri 3x3 mm.
- + Con l’utilizzo del telaio di movimentazione con ventose di sicurezza portare la lastra in posizione verticale e posarla.
- + Per garantire l’incollaggio totale della lastra ed espellere l’aria, battere dal centro verso i bordi con il battitore in plastica antirimbalzo. Non utilizzare martelli
- + Utilizzo di sistema livellante a tirate / livellatore
- + Prima di procedere con l’incollaggio della lastra successiva, è possibile fissare il gancio di sicurezza meccanico a scomparsa alla parete tramite appositi chiodi per inchiodatrice a gas. Al fine di garantire la qualità del fissaggio del gancio meccanico si raccomanda l’utilizzo di idonea inchiodatrice a gas in grado di garantire un costante apporto di energia.

222



The laying system with hidden mechanical safety hook on 6 mm “ULTRA” slabs allows the wall covering to be installed in complete safety with a great impact.

For this application system, the “ULTRA” slab is pre-processed in the factory, so that it is delivered to the site already equipped with the hidden mechanical safety hook, sealed onto the back of the slab and complete with protective film on the back.

For smaller quantities it is possible to carry out such work directly on site, using the appropriate tools and safety gloves.

Il sistema di posa con gancio meccanico di sicurezza a scomparsa su lastre “ULTRA” da 6 mm consente di realizzare in totale sicurezza un rivestimento incollato a parete di grande impatto.

Per questo sistema di applicazione, la lastra “ULTRA” verrà pre-lavorata in stabilimento, giungendo in cantiere già dotata del gancio meccanico di sicurezza a scomparsa, sigillato sul retro della lastra e provvisto di pellicola di protezione retro lastra.

Per quantità non elevate, è possibile eseguire tale lavorazione direttamente in cantiere, tramite l’uso degli appositi utensili e ganci di sicurezza



RETRACTABLE SAFETY HOOK SYSTEM

The laying system with retractable mechanical safety hook on 6 mm slabs allows the wall covering to be installed in complete safety and have great impact.

For this application system, the slab will be pre-processed in the factory, and will be delivered at the site already equipped with the retractable mechanical safety hook.

SISTEMA GANCIO DI SICUREZZA A SCOMPARSA

Il sistema di posa con gancio meccanico di sicurezza a scomparsa su lastre da 6 mm consente di realizzare in totale sicurezza un rivestimento incollato a parete di grande impatto. Per questo sistema di applicazione, la lastra verrà pre-lavorata in stabilimento, giungendo in cantiere già dotata del gancio meccanico di sicurezza a scomparsa.



INSTRUMENTS REQUIRED

- + Handling frame with suction cups and a transport truck with wheels or double suction cups.
- + Cement-based powder adhesive for full spread, class "C2E according to EN 12004 and S1 according to EN 12002 standards".
- + 10x10 mm square toothed trowel.
- + 3x3 mm square toothed trowel.
- + Hidden mechanical safety hook
- + Gas-powered nailing machine and relative nails.

STRUMENTAZIONE NECESSARIA

- + Telaio di movimentazione con ventose di sicurezza dotato di carrello per il trasporto con ruote o biventosa.
- + Collante in polvere a base cementizia a letto pieno di classe "C2E secondo le normative EN 12004 e S1 secondo la normativa EN 12002".
- + Spatola a denti quadri 10x10 mm.
- + Spatola denti quadri 3x3 mm.
- + Gancio di sicurezza meccanico a scomparsa.
- + Inchiodatrice a gas e relativi chiodi.

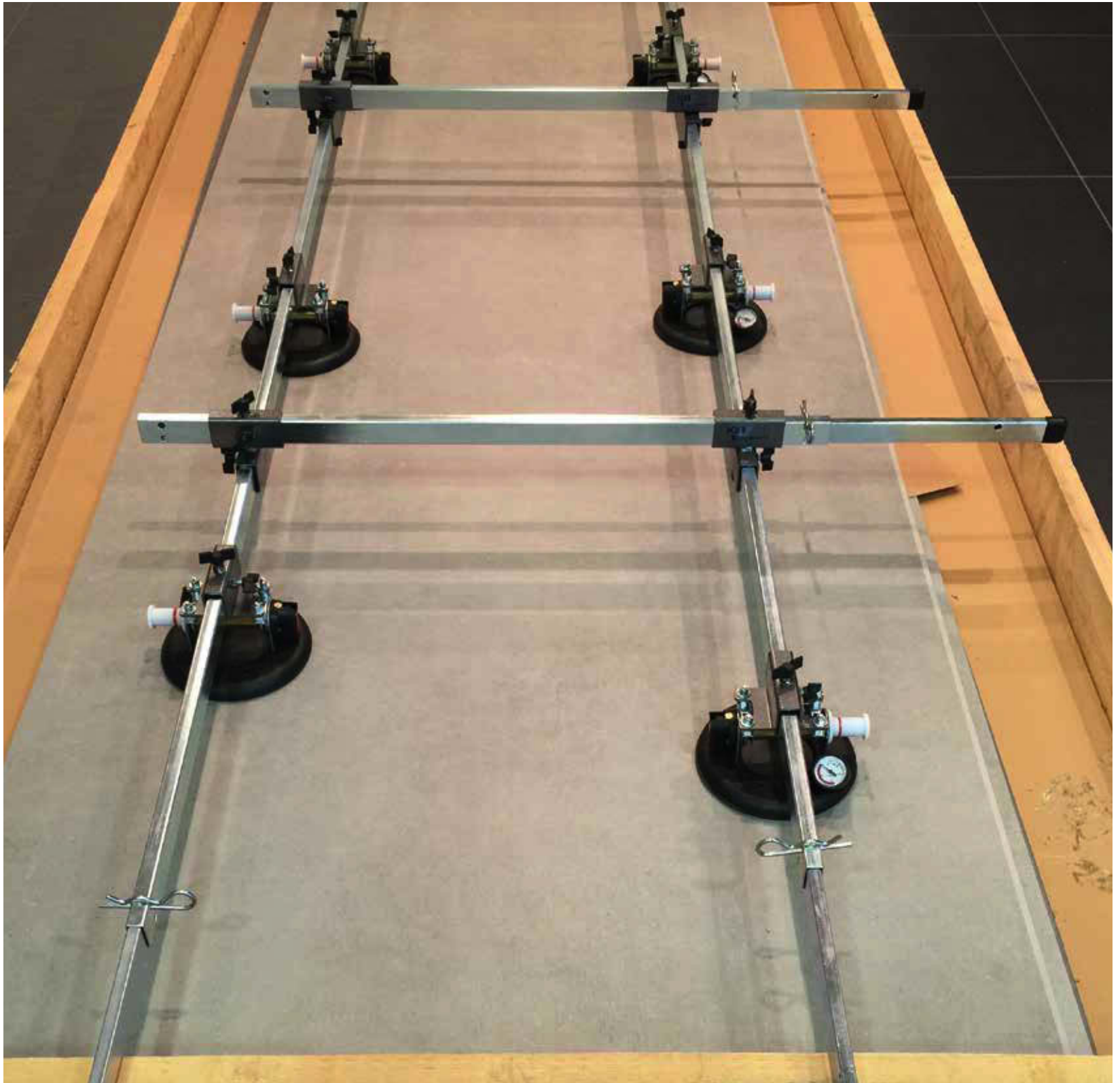

CLEANING AND MAINTAINANCE PULIZIA E MANUTENZIONE

All Ariostea materials are easy to clean and maintain. Regular cleaning highlights the aesthetic features of the material and gives the floor an exceptional shine.

JOINTING AND FINAL CLEANING

When the floor has been laid using normal setting adhesives, joint the tiles after 24/48 hours, in the case of quick setting adhesives, after 4 hours.

- Especially with honed and polished materials, use cement-based grout with tone on tone colours (if possible avoid dark coloured grouts like black, blue, red with light coloured materials and vice-versa). For jointing these surfaces, do not use epoxy grouts or flexible mortar with a synthetic base (Flexfughe) especially if the colour contrasts with the material and do not add additives/latex to the grout. These products in fact make it extremely difficult to eliminate the residues with normal cleaning products. Should this kind of grout be used anyway, take care of testing it on the material beforehand.
- Spread the grout with a rubber spatula all over the material surface.
- Joint small areas at a time, removing the excess with damp sponges or rags (using only clean water) or with special machines for removing the excess grout while this is still damp.
- Proper initial cleaning is fundamental both for enhancing its aesthetic and shine characteristics and for restoring its original characteristics of easy cleaning and ease of ordinary maintenance. It is therefore very important that initial cleaning is carried out immediately after installation, rubbing hard with acid-based products, followed by abundant rinsing with water. In this way it will be possible to eliminate the residues of grout, adhesive, cement, etc. It is possible to use any of the detergents available on the market, with the exclusion only of products containing hydrofluoric acids (composites and derivatives) according to EN standard 14411.
- The floor must be carefully protected. Should it be necessary to carry out other operations such as decorating, plumbing or any other kind of work, once the floor has been installed it is advisable to cover it with PVC or AIRBALLS sheets or cloths.

MAINTENANCE AND CARE

Thanks to the characteristics of the production process (high firing temperature, raw materials of great quality, sinterizing process), the surface of Ariostea material is waterproof (the water absorption is minimum). For standard maintenance we recommend to use neutral waxless detergents in order to avoid greasy films and to alternate, if necessary, with some occasional washings made with alkaline products in weak concentration and abundantly rinsed at the end.

After the installation of floors, particularly of those made with polished materials, the surfaces should be adequately protected with particle board or other suitable materials in order to protect them from dirt and on-site processing. This prevents damage caused by subsequent processing.

Tutti i materiali Ariostea sono di facile pulizia e di semplice manutenzione. Una pulizia adeguata ne valorizza le caratteristiche estetiche donando ad ogni pavimento un'eccezionale brillantezza.

STUCCATURA E PULIZIA FINALE

Con collanti a presa normale, stuccare il pavimento dopo 24/48 ore, se si utilizzano adesivi rapidi dopo 4h.

- Soprattutto sui materiali levigati lucidati utilizzare stucchi cementizi con colori tono su tono, evitando su materiali chiari, stucchi di colore scuro e viceversa. Per la stuccatura di queste superfici non adoperare stucchi epossidici o malte flessibili a base di materiali sintetici (Flexfughe) soprattutto se a contrasto col colore del materiale e non aggiungere additivi/lattici allo stucco. Essi infatti rendono estremamente difficoltosa l'eliminazione dei residui con i normali prodotti di pulizia. Se si decide comunque di utilizzare questa tipologia di stucco, testarli sempre prima sul materiale.
- Stendere lo stucco con spatola gommata su tutta la superficie del materiale.
- Stuccare piccole superfici per volta, asportando le quantità eccedenti con spugne o stracci umidi (di sola acqua pulita) o utilizzare apposite macchine per togliere lo stucco eccedente, quando ancora il velo di stucco è umido.
- Un'adeguata pulizia iniziale è fondamentale sia per valorizzare la brillantezza, sia per assicurare la pulibilità e la semplicità di manutenzione ordinaria. La pulizia iniziale va quindi effettuata immediatamente dopo la posa, utilizzando prodotti a base acida, strofinando energicamente e sciacquando abbondantemente con acqua. In questo modo sarà possibile eliminare i residui di stucco, collante, cemento, ecc. E' possibile utilizzare tutti i detergenti disponibili sul mercato, con unica esclusione dei prodotti contenenti acido fluoridrico (composti e derivati) come previsto dalla norma EN 14411.
- Si raccomanda una accurata protezione del pavimento posato. Qualora sia necessario eseguire altre operazioni quali tinteggiatura, lavori idraulici o qualsiasi altro lavoro, si consiglia, terminata la posa, di coprire il pavimento con teli PVC o AIRBALLS o tessuti.

MANUTENZIONE E CURA

Grazie al procedimento produttivo impiegato (alte temperature di cottura, materie prime di qualità e processo di sinterizzazione) la superficie dei materiali Ariostea è praticamente impermeabile (assorbimento d'acqua minimo). Per la manutenzione ordinaria si consiglia di utilizzare detergenti neutri privi di cere o prodotti ceranti onde evitare la formazione di strati untuosi, alternando se necessario saltuari lavaggi con detergenti alcalini in concentrazione blanda ben sciacquati al termine.

Al fine di preservare le superfici dallo sporco e dalle lavorazioni di cantiere, a posa terminata le pavimentazioni, in particolar modo quelle realizzate con materiali levigati, devono essere adeguatamente protette con truciolare o altri materiali idonei. In tal modo sarà possibile evitare danneggiamenti provocati da lavorazioni successive.

REINIGUNG UND PFLEGE NETTOYAGE ET ENTRETIEN

Alle Ariostea Materialien sind Pflegeleicht und einfach zu reinigen. Eine fachgerechte Reinigung bringt die ästhetischen Eigenschaften des Materials am besten zur Geltung und schenkt dem Bodenbelag ein außergewöhnlichen Glanz.

VERFUGUNG UND ENDREINIGUNG

Bei der Verlegung mit normal härtenden Klebern, den Boden nach 24 / 48 Stunden, bei der Verwendung von Schnellklebern bereits nach 4 Stunden verfugen.

- Insbesondere auf den glanzpolierten Materialien sollten Zementkitt in ähnlichen Farbtönen verwendet werden (es sollte vermieden werden, auf hellen Materialien dunkle, beispielsweise schwarze, blaue oder rote Kitt zu verwenden; dasselbe gilt für helle Kitt auf dunklen Fliesen).
- Für das Verfugen dieser Oberflächen auf keinen Fall kunsthartgebundenen Fugenmörtel oder bewegliche Mörtel auf Basis von synthetischen Materialien (z.B. Flexfughe) verwenden, vor allem nicht in Kontrastfarbe zur Fliese. Außerdem dürfen dem Kitt keine Zusatzstoffe oder Latex zugeschlagen werden, da durch diese Zuschläge die Entfernung der Restrückstände mit den normalen Reinigungsmitteln extrem erschwert wird. Sollen Sie sich dennoch für einen kunsthartgebundenen Fugenmörtel entscheiden, testen Sie diesen vorher auf dem Material.
- Den Kitt mit einer Gummispachtel auf der gesamten Materialoberfläche gleichmäßig auftragen.
- Die kleinen Oberflächen einzeln verfugen und die entsprechenden Restrückstände mit einem feuchten Schwamm oder Lappen (der nur in reines Wasser getaucht wurde) entfernen, oder spezielle Maschinen für das Entfernen von Restrückständen verwenden, wobei der Kitt noch feucht sein muß.
- Eine korrekte anfängliche Reinigung ist besonders wichtig, weil somit sowohl die ästhetischen Besonderheiten und der Glanz des Materials hervorgehoben werden, und zudem die zukünftigen und lang anhaltenden Eigenschaften der einfachen Reinigung und der praktischen regelmäßigen Pflege dieses Materials zur Geltung kommen können.
Es ist deshalb sehr wichtig, daß die erste Reinigung mit säurehaltigen Reinigungsmitteln sofort nach der Verlegung des Materials erfolgt, wobei die Fliesen fest zu reiben und dann gründlich mit frischem Wasser zu spülen sind. Auf diese Weise können alle Restrückstände von Kitt, Kleber, Zement usw. gründlich entfernt werden. Zu diesem Zweck können alle erhältlichen Reinigungsmittel verwendet werden, mit Ausnahme aller Produktartikel, die Fluorwasserstoffsäure (Verbindungen und Derivate) enthalten, laut der Vorschrift EN 14411.
- Es wird empfohlen, den verlegten Boden sorgfältig zu schützen. Sollten andere Arbeiten, wie zum Beispiel das Färben, das Verlegen von Heizungen und Wasserleitungen oder ähnliches erforderlich sein, empfehlen wir den Boden nach dem Verlegen mit Planen aus PVC, AIRBALLS oder Gewebepapieren abzudecken.

WARTUNG UND PFLEGE

Dank des angewandten Produktionsverfahrens (hohe Brenn-temperatur, qualitativ hochwertiges Rohmaterial und Sinterung) ist die Oberfläche der Ariostea Materialien praktisch völlig wasserabweisend (minimale Feuchtigkeit Aufnahme).

Für die tägliche Unterhaltung empfehlen wir die Verwendung von neutralem Reiniger. Es ist davon abzuraten, wachshaltige Reinigungsmittel oder Produkte zum Einwachsen zu verwenden, um die Bildung von öligen Schichten zu vermeiden. Hin und wieder kann man bei Bedarf eine Reinigung mit einem in Wasser verdünnten alkalischen Mittel durchführen, welcher nachträglich mit klarem Wasser sorgfältig abgewaschen werden soll.

Um die Oberflächen vor Verschmutzungen und Beschädigungen durch Bauarbeiten zu schützen, müssen die Bodenbeläge, insbesondere die aus geschliffenen Materialien, nach der Verlegung entsprechend mit Spanplatten oder anderen geeigneten Materialien abgedeckt werden. Auf diese Weise können Beschädigungen durch spätere Arbeiten vermieden werden.

Tous les produits Ariostea, sont faciles à nettoyer et simples à l'entretien.

Un nettoyage adéquat, améliore ses caractéristiques esthétiques, en donnant à chaque carrelage un éclat exceptionnel.

JOINTOIEMENT ET NETTOYAGE FINAL

En cas de pose avec des adhésifs à prise normale, jointoyer le sol après 24/48 heures; si l'on utilise des adhésifs à prise rapide, après 4h.

- Sur les matériaux polis lustrés surtout, utiliser des mortiers-joints avec des couleurs ton sur ton (éviter si possible sur des matériaux de couleur claire des mortiers de couleur foncée comme le noir, le bleu, le rouge et vice-versa).
- Pour le jointoiment de ces surfaces, ne pas utiliser Mastics époxydes ou de mortiers flexibles à base de matériaux synthétiques (Flexfughe) surtout s'il y a contraste avec la couleur du matériau, et ne pas ajouter d'additifs/lactiques au mastic. En effet, ces derniers rendent l'élimination des résidus extrêmement difficile avec les nettoyeurs normaux. Si de toute façon on décide de continuer à utiliser ce type de mortier il faudra toujours le tester avant.
- Étaler le mortier à la spatule caoutchoutée sur toute la surface du matériau.
- Jointoyer de petites surfaces à la fois en enlevant les quantités en excès avec une éponge ou des chiffons humidifiés (exclusivement d'eau propre) ou utiliser des machines spéciales pour enlever le mortier en excès quand le voile de mortier est encore humide.
- Un nettoyage initial adapté est d'une importance fondamentale aussi bien pour mettre en valeur les caractéristiques esthétiques et de brillance, que pour rétablir les caractéristiques de facilité de nettoyage et d'entretien ordinaire. C'est la raison pour laquelle il est fondamental que le nettoyage initial soit effectué immédiatement après la pose, en utilisant des produits à base acide, en frottant énergiquement et, par la suite, en frottant abondamment avec de l'eau. Il sera ainsi possible d'éliminer les résidus de mortier, d'adhésif, de ciment, etc. Il est possible d'utiliser tous les nettoyeurs disponibles sur le marché, à l'exception des produits contenant de l'acide fluorhydrique (composés et dérivés) comme le prévoit la norme EN 14411.
- Il est recommandé de protéger soigneusement le sol posé. S'il s'avère nécessaire d'exécuter d'autres opérations comme la peinture, les travaux de plomberie ou autre, une fois la pose terminée, nous conseillons de couvrir le sol avec des bâches en PVC ou AIRBALLS ou avec du tissu.

ENTRETIEN ET SOIN

Grâce aux caractéristiques du procédé de production (hautes températures de cuisson, matières premières de qualité et procédé de grésage) la surface des matériaux Ariostea est pratiquement imperméable (l'absorption d'eau est minimum). Pour l'entretien quotidien, nous conseillons d'utiliser des détergents neutres, sans cire ou produits de cirage, afin d'éviter la formation de couches de graisse. Si nécessaire, alterné des lavages occasionnel avec des détergents alcalins abondamment dilués et bien rincés à la fin.

Après avoir achevé la pose des sols, notamment ceux réalisés avec des matériaux polis, il faut protéger comme il se doit, les surfaces contre la saleté et résidus de chantier, en appliquant des panneaux de particules ou autre matériaux similaires. Il sera ainsi possible d'éviter que les opérations suivantes n'abîment le carrelage.

OVERVIEW OF LAYING INSTRUCTIONS

TAVOLA RIEPILOGATIVA DELLE ISTRUZIONI DI POSA

	CLADDING / RIVESTIMENTO		FLOORING* PAVIMENTAZIONE*	
	INTERNAL / INTERNO	EXTERNAL / ESTERNO	INTERNAL / INTERNO	EXTERNAL / ESTERNO
MINIMUM RECOMMENDED JOINT FUGA MINIMA CONSIGLIATA	≥1 mm	≥5 mm	≥1 mm	≥5 mm
GLUE APPLIED WITH DOUBLE COATING COLLA APPLICATA CON DOPPIA SPALMATURA	SI	SI	SI	SI
USE OF LEVELLING SYSTEMS UTILIZZO DI SISTEMI LIVELLANTI	SI	SI	SI	SI
SUGGESTED ADHESIVES ADESIVI SUGGERITI	See the specific table on page 228 Vedi la specifica tabella riportata a pag. 228			

SUGGESTED ADHESIVES / ADESIVI SUGGERITI

SURFACE, FONDO

+ FLOORING
only 6 mm thick slabs

+ PAVIMENTAZIONE
solo lastre con spessore 6 mm

- Cement screeds, heated screeds, concrete, ceramic, tiles, stone materials

- Massetti cementizi, massetti riscaldanti, calcestruzzo, ceramica, marmette, materiali lapidei.

- Other cement or epoxy type resin, gum, metal, etc. bases.

- Altri fondi tipo resina cementizia o epossidica, gommosi, metalli, ecc...

+ INTERIOR CLADDING
6 mm thick slabs

+ RIVESTIMENTI INTERNI
lastre con spessore 6 mm

- Surfaces treated in plaster or gypsum (if prepared), plasterboard, concrete, fibre cement, continuous or industrial block masonry.

- Superfici trattate a intonaco o gesso (se predisposte), cartongesso, cemento, fibrocemento, muratura continua o a blocchi industriali.

- Ceramic, recomposed marble tiles and stone materials, marble and stone slabs, concrete.

- Ceramica, piastrelle in marmo ricomposto, lastre di marmo e materiali lapidei, calcestruzzo.

- Metallic surfaces, industrial panels based on wooden derivatives.

- Superfici metalliche, pannelli industriali a base di derivati lignei.

+ EXTERNAL CLADDING
6 mm thick slabs

+ RIVESTIMENTI ESTERNI
lastre con spessore 6 mm

- Concrete

- Calcestruzzo

- Plaster

- Intonaco

+ CLADDING
FOR OTHER SUPPORTS
6 mm thick slabs

+ RIVESTIMENTO
ALTRI SUPPORTI
lastre con spessore 6 mm

- Industrial wooden or metallic supports, etc.

- Supporti industriali lignei o metallici, ecc...



CLASS, CLASSE	PRODUCT, PRODOTTO
C2TES1 C2ES2 C2TES1 C2TES2 C2TES1	ULTRALITES1 - Mapei KERABOND + ISOLASTIC - Mapei H40 ECO EXTRAFLEX - Kerakoll LATICRETE 335 + LATICRETE 333 - Laticrete SUPERFLEX K77 - Litokol
R2 R2T R2T R2T	KERALASTIC - Mapei SUPERFLEX ECO - Kerakoll LATALASTIK - Laticrete LITOELASTIC - Litokol
C2TES1 C2ES2 R2T C2TES1 C2TES1	ULTRALITES1 - Mapei KERABOND + ISOLASTIC - Mapei SUPERFLEX ECO - Kerakoll LATICRETE 335 + LATICRETE 282 - Laticrete SUPERFLEX K77 - Litokol
C2ES2 R2T C2TES2 C2S2	KERABOND + ISOLASTIC - Mapei SUPERFLEX ECO - Kerakoll LATICRETE 335 + LATICRETE 333 - Laticrete SUPERFLEX K77 - Litokol
R2T R2T R2T R2T	KERALASTIC T - Mapei SUPERFLEX ECO - Kerakoll LATALASTIK - Laticrete LITOELASTIC - Litokol
C2ES2 C2ES2 R2T C2TES2 C2S2	ULTRALITES2 - Mapei KERABOND + ISOLASTIC - Mapei SUPERFLEX ECO - Kerakoll LATICRETE 335 + LATICRETE 333 - Laticrete CEMENTKOL K21 + LATEXKOL - Litokol
C2ES2 R2T C2TES2 C2S2	KERABOND + ISOLASTIC - Mapei SUPERFLEX ECO - Kerakoll LATICRETE 335 + LATICRETE 333 - Laticrete CEMENTKOL K21 + LATEXKOL - Litokol
R2 R2T R2T R2T	KERALASTIC - Mapei SUPERFLEX ECO - Kerakoll LATALASTIK - Laticrete LITOELASTIC - Litokol



KIT ULTRA CASE is distributed by Technoriunite Srl, for further information: www.technoriunite.it



Il KIT ULTRA CASE è distribuito da Technoriunite Srl, per ulteriori informazioni: www.technoriunite.it

230



KIT ULTRA CASE

KIT ULTRA CASE and KIT ULTRA CASE PLUS contain all the instruments required for the correct application of the “ULTRA” slabs in the different stages: handling, cutting, making holes and laying.

ULTRA CASE KIT **1** comprises:

- + Cutting guide with cutting carriage for linear or diagonal cuts of up to 320 cm.
- + Cutting pliers.
- + Diamond buffer.
- + 6 wet diamond core bits “cup wheel cutters” (dimension Ø 60 mm, 40 mm, 35 mm, 10 mm, 8 mm and 7 mm).
- + 3x3 mm square toothed trowel for use at the back of the slab and 10 x 10 mm square toothed trowel.
- + Non-bounce plastic mallet 170x370 mm.
- + 2 double suction cups.

ULTRA CASE PLUS KIT **1** + **2** comprises:

- + Cutting guide with cutting carriage for linear or diagonal cuts of up to 320 cm.
- + Cutting pliers.
- + Diamond buffer.
- + 6 wet diamond core bits “cup wheel cutters” (dimension Ø 60 mm, 40 mm, 35 mm, 10 mm, 8 mm and 7 mm).
- + 3x3 mm square toothed trowel for use at the back of the slab and 10 x 10 mm square toothed trowel.
- + Non-bounce plastic mallet 170x370 mm.
- + 2 double suction cups.
- + Handling frame with suction cups.
- + Transport truck for large format slabs.

On request, the puller/leveller levelling system can also be supplied, which is strongly recommended for laying “ULTRA” slabs.

Il KIT ULTRA CASE ed il KIT ULTRA CASE PLUS contengono tutte le strumentazioni necessarie per la corretta applicazione delle lastre “ULTRA” nelle sue diverse fasi: movimentazione, taglio, fori e posa in opera.

Il KIT ULTRA CASE **1** si compone di:

- + Guida da taglio con carrello incisore per tagli fino a 320cm lineari o diagonali.
- + Pinza troncatrice.
- + Tampone diamantato.
- + 6 foretti diamantati per foratura a umido “frese a tazza” (dimensione Ø 60 mm, 40 mm, 35 mm, 10 mm, 8 mm e 7 mm).
- + Spatola a denti quadri 3x3 mm per uso retro lastra e spatola a denti quadri 10x10 mm.
- + Battitore in plastica antirimbalzo 170x370 mm.
- + 2 biventose.

Il KIT ULTRA CASE PLUS **1** + **2** si compone di:

- + Guida da taglio con carrello incisore per tagli fino a 320cm lineari o diagonali.
- + Pinza troncatrice.
- + Tampone diamantato.
- + 6 foretti diamantati per foratura a umido “frese a tazza” (dimensione Ø 60 mm, 40 mm, 35 mm, 10 mm, 8 mm e 7 mm).
- + Spatola a denti quadri 3x3 mm per uso retro lastra e spatola a denti quadri 10x10 mm.
- + Battitore in plastica antirimbalzo 170x370 mm.
- + 2 biventose.
- + Telaio di movimentazione con ventosa di sicurezza
- + Carrello per trasporto lastre grandi formati.

A richiesta può esser fornito anche il sistema livellante a tirante / livellatore vivamente consigliato per la posa delle lastre “ULTRA”.

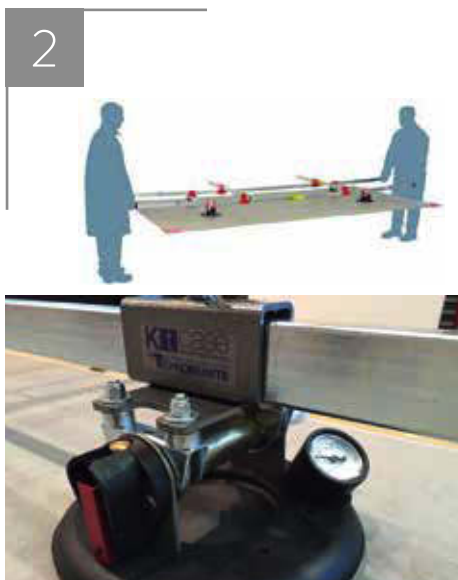



CUTTING GUIDE WITH ENGRAVING UNDERCARRIAGE
GUIDA DA TAGLIO CON CARRELLO INCISORE

232



DESCRIPTION - DESCRIZIONE

- + Cuttings up to 320 linear and diagonal cm
- + Per tagli fino a 320 cm lineari e diagonali
- + Linear slab cutting machine
- + Macchina per taglio lineare Lastra

DRILLING: Ø AVAILABLE
FORATURA: Ø DISPONIBILI

DESCRIPTION / DESCRIZIONE



- + Wet bit
- + Foretto umido

Ø mm

60

40

35

10

8

7



TOOLS / ATTREZZI

DESCRIPTION / DESCRIZIONE



- + Rubber 10 x 10 mm tooth 28 x 12 trowel
- + Spatola 28 x 12 dente 10 x 10 mm gomma



- + Rubber 3 x 3 mm tooth 28 x 12 trowel
- + Spatola 28 x 12 dente 3 x 3 mm gomma



- + Dual suction cups 90
- + Biventosa 90



- + 140 x 350 mm rubber mallet
- + Battitore con gomma 140 x 350 mm



- + 55 x 90 diamond buffer
- + Tampone diamantato 55 x 90

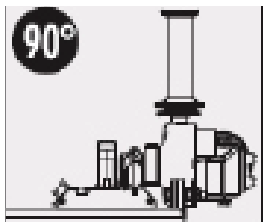

CUT LINEAR
90° PLUNGE CUTTING UNIT WITH
ANGLE GRINDER

- + To perform particularly problematic cuts avoiding any risk of material breakage.
- + To be mounted on cutting guides (max cutting length: 426 m – 14.’).
- + Tilting movement (plunge cut) to adjust the depth of cut and to make cuts in multiple passes as well as to perform cut in the middle of the slab, square and rectangular holes.
- + Depth of cut: 25 mm (1”) with disc Ø 150 mm (6”); 15 mm (3/8”) with disc Ø 125 mm (5”)
- + Equipped with semi-universal attachment: compatible with the most popular brands and models of angle grinders.
- + Dry cut with diamond disc.
- + Provision for dust extraction.
- + Disc Ø: min 125 mm (5”); max 150 mm (6”).

CUT LINEAR
GRUPPO DI TAGLIO BASCULANTE CON
SMERIGLIATRICE ANGOLARE PER TAGLI A 90°

- + Per eseguire tagli particolarmente problematici evitando ogni rischio di rottura del materiale.
- + Da applicare a guide di taglio (max lunghezza di taglio: 425 cm) per tagli a 90°.
- + Movimento basculante (a troncatrice) per regolare la profondità di taglio e quindi eseguire tagli in più passate nonché eseguire scassi, fori quadri e rettangolari.
- + Massimo spessore di taglio: 25 mm (con disco Ø 150 mm).
- + Dotato di aggancio semi-universale: compatibile con le più diffuse marche e modelli di smerigliatrici angolari.
- + Taglio a secco con disco diamantato.
- + Predisposizione per aspirazione polveri.
- + Diametro disco: minimo Ø 125 mm; massimo Ø 150 mm.

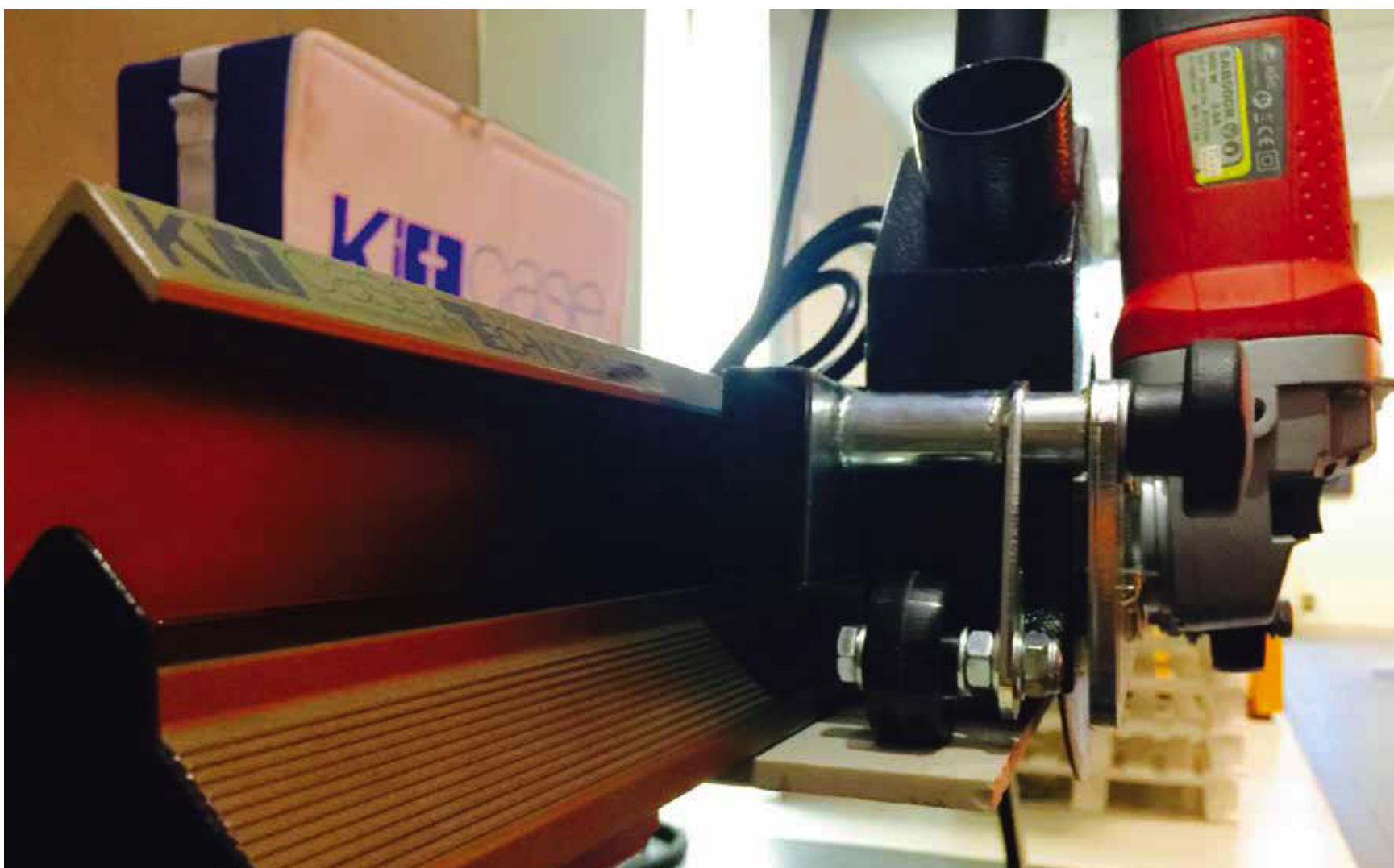

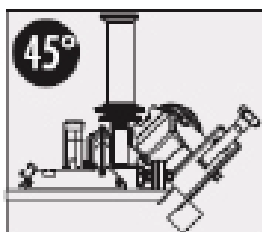
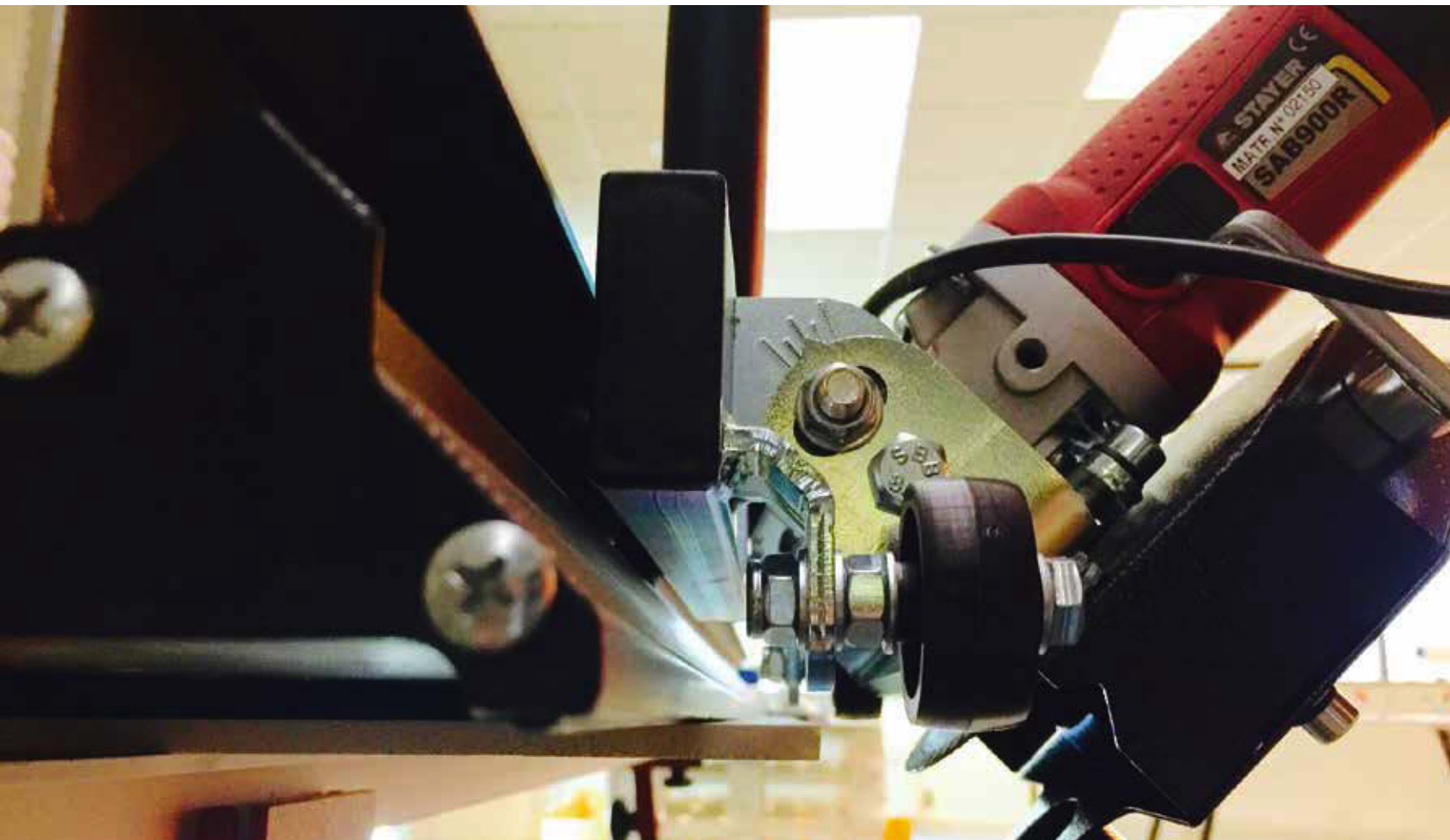

CUT JOLLY
35°/55° CUTTING UNIT
WITH ANGLE GRINDER

CUT JOLLY
GRUPPO DI TAGLIO CON SMERIGLIATRICE
ANGOLARE PER TAGLI AD ANGOLAZIONE
VARIABILE 35°/55

Provided with tiling system to miter angle between 35° and 55°. To be mounted on cutting guides (max length of cut: 425 cm - 14').

- + Dry cut with diamond blade.
- + Provided with clutch hose for dust extraction.
- + Depth of cut: 20 mm (3/4") with disc Ø 150 mm (6"); 15 mm (5/8") with disc Ø 125 mm (5").
- + Equipped with semi-universal attachment: compatible with the most popular brands and models of angle grinders.
- + Disc Ø: min 125 mm (5"); max 150 mm (6").

Per eseguire tagli ad angolo variabile compreso tra 35° e 55°.
Da applicare a guide di taglio (max lunghezza di taglio: 425 cm).

- + Taglio a secco con disco diamantato.
- + Predisposizione per l'aspirazione polveri.
- + Massimo spessore di taglio: 20 mm con disco Ø 150 mm; 15 mm con disco Ø 125 mm.
- + Dotato di aggancio semi-universale: compatibile con le più diffuse marche e modelli di smerigliatrici angolari.
- + Diametro disco: minimo Ø 125 mm; massimo 150 mm.

KIT SAFETY is a kit to create the retractable safety hook system for coatings with porcelain stoneware slabs.

DESCRIPTION: The retractable mechanical fixing device in stainless steel is a device to help hold, it is inserted before laying, and is then fixed to the wall with plugs or nails.

AREAS OF USE: Safety anchor for bonded façades, an outdoor coating system to secure façades fixed with adhesive. Positioned behind the tile, marble, artefact or product suitable for bonding to a wall. With the rise of large formats, the hook prevents slabs from falling off a wall in the event the adhesive fails.

APPEARANCE: Stainless steel slab with pre-set tab to insert on the back of the tile, after milling, with 2 brakes to prevent their falling. The perforated side allows the slab to be positioned against the wall with a nail or plug.

MATERIAL: Stainless Steel

DIMENSIONS: Dimension of the Small Slab: 120x40 mm thickness 5/10 mm Bore diameter: 9 mm and 10 mm Thickness: 0.5/0.10 mm

SURFACE TYPE: The product is greasy to the touch, we recommend cleaning before use.

ADHESIVE RECOMMENDATIONS: We recommend installing the Hook with Two-component Polyurethane adhesive.

236 ASSEMBLY DESCRIPTION: Insert the tab inside the slot, seal with suitable adhesive, let dry, and fix to the wall with a nail or plug. Flexible door device with angle grinder and diamond blade for construction site milling, indispensable to fix the retractable hook.

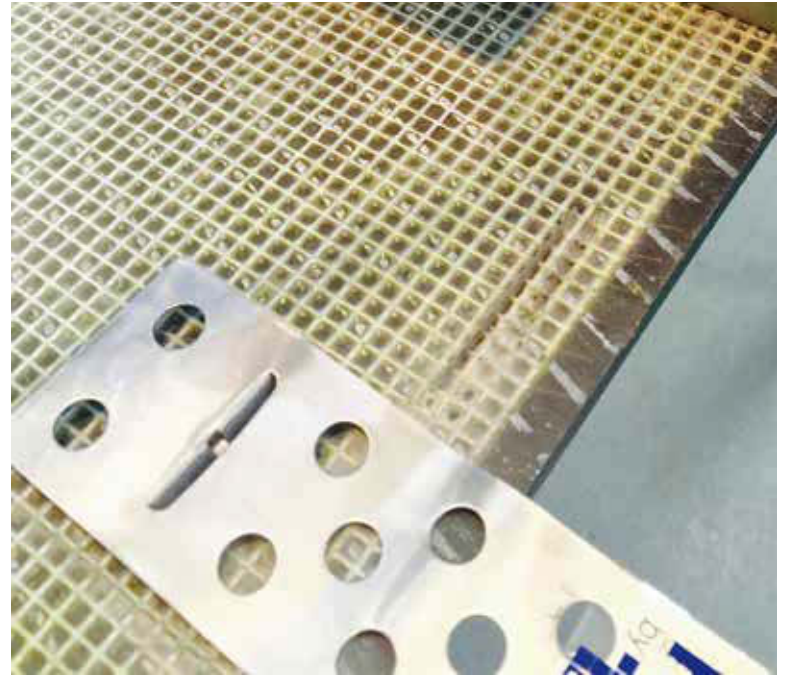

KIT SAFETY è il kit per la realizzazione del sistema gancio di sicurezza a scomparsa per i rivestimenti con lastre in gres porcellanato.

DESCRIZIONE: Dispositivo di fissaggio meccanico a scomparsa in acciaio inox di ausilio alla tenuta è un dispositivo che viene inserito prima della posa, per poi essere fissato a parete tramite tasselli o chiodi.

CAMPI D'IMPIEGO: Ancoraggio di sicurezza per facciate incollate sistema da rivestimento per esterno che permette la messa in sicurezza delle facciate posate a colla. Viene posizionato sul retro della piastrella, marmo, manufatto o prodotto che si presti a essere incollato a parete. Con l'avvento dei grandi formati, il gancio, evita la caduta di lastre da parete nell'eventualità del distacco del collante.

ASPETTO: Lastra in acciaio inox con linguetta preposta per l'inserimento su retro piastrella, previa fresatura, dotato di 2 freni per impedirne la fuoriuscita. La parte forata consente di posizionare la lastra a parete, con chiodo o tassello.

MATERIALE: Acciaio Inox

DIMENSIONI: Dimensioni Lastrina: 120x40 mm spessore 5/10mm. Diametro fori: 9mm e 10mm. Spessore: 0.5/0.10mm

STATO SUPERFICIALE: Il prodotto si presenta oleoso al tatto, si consiglia pulitura prima dell'uso.

INDICAZIONI COLLANTI: Si consiglia di installare il Gancio con collante Poliuretano Bicomponente.

DESCRIZIONE DEL MONTAGGIO: Inserire la linguetta all'interno della fresatura sigillare con apposito collante lasciare asciugare, fissare a parete con chiodo o tassello.



MODULAR BENCH Easy to disassemble and once not mounted it has small dimensions. This make it easy to transport.

Easy to mount.

The steel structure and the worktop made of anodized aluminum profiles guarantee sturdiness and stability.

Legs provided with adjustable rubber feet. Provided with adjustable anodized aluminum profiles so to avoid to interfere with diamond disc if cutting slabs with angle grinder.

Worktop dimensions: 180 x 90 cm (3'x6'). Height: 83 cm (32 3/4"), for 360x90 cm (11.8'x6').

Provided with special connection devices to join more bench so to expand worktop dimensions.

BANCO DI LAVORO MODULARE Facilmente assemblabile/smontabile e di minimo ingombro per un agevole trasporto.

La struttura in acciaio ed il piano di lavoro in profilati d'alluminio anodizzato ne garantiscono robustezza e stabilità.

Gambe provviste di piedini regolabili. Profilati in alluminio anodizzato registrabili per evitare di interferire col disco diamantato nel caso si eseguano tagli con smerigliatrice angolare ("flex").

Dimensioni piano di lavoro da 180 x 90 cm.

Altezza 83 cm, fino a 360x90 cm.

Provisto di appositi dispositivi di aggancio per combinare più banchi tra loro ed aumentare le dimensioni del piano.



237

ACCESSORIES / ACCESSORI



TILE STOP

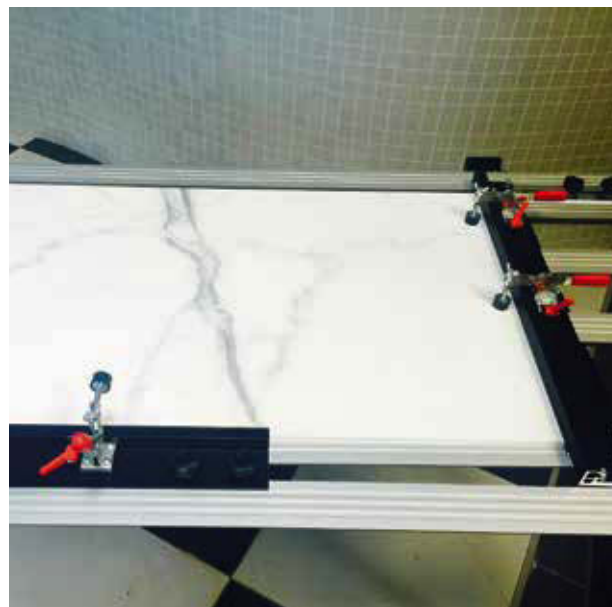

TILE SQUARE



TILE SAFETY SUPPORT

KIT POLISH: n.1 support and n.6 diamond resin polishing pads whit Velcro coupling for dry or wet grinding and polishing.

KIT POLISH: n.1 supporto e n. 6 dischi diamantati resinoidi con attacco Velcro per la levigatura e lucidatura a secco o umido.



CORNER PROTECTORS n. 4 pieces

PARASPIGOLI n. 4 pezzi



CUT11 is a screw cutter for the separation of slabs up to 11mm thickness. After engraving the slab using the cutting guide with engraving undercarriage Kit Case, start cutting placing CUT11 next to the line you have engraved. The progressive pressure exerted by the screw cutter will allow the linear cutting of the slab.

CUT11 è un troncatore a vite per la separazione delle lastre di spessore fino a 11mm . Dopo aver inciso la lastra utilizzando la guida da taglio con carrello incisore del Kit Case, iniziare la troncatura posizionando CUT11 in corrispondenza della linea incisa sulla lastra. La pressione progressiva esercitata dal troncatore a vite, permetterà la troncatura lineare della lastra.



CARATTERISTICHE TECNICHE / TECHNICAL FEATURES TECHNISCHE EIGENSCHAFTEN / CARACTÉRISTIQUES TECHNIQUES

INFORMAZIONI TECNICHE AGGIUNTIVE / ADDITIONAL TECHNICAL INFORMATION / ZUSÄTZLICHE TECHNISCHE INFORMATIONEN / INFORMATION TECHNIQUE SUPPLÉMENTAIRE

• La trasformazione di materie prime naturali, associata all'utilizzo di innovative tecnologie di produzione brevettate, consente di ottenere materiali dalle elevate prestazioni tecniche, che si distinguono per i tipici effetti a tutto spessore da sempre prerogativa esclusiva dei marmi e delle pietre di cava.

• Le variazioni cromatiche, di venatura e le piccole puntature sono pertanto caratteristiche di alto pregio dei materiali Ariostea, ricercate e volute proprio al fine di ricreare la suggestione di una pavimentazione esclusiva, in cui si possa riscoprire la casualità e la bellezza dei materiali naturali. In ragione di quanto sopra i riferimenti cromatici presentati su cataloghi e campionature sono da intendersi puramente indicativi.

• Le lastre delle collezioni High-Tech sono realizzate in massa unica, compatta, ingeliva e resistente agli attacchi chimici. Esse sono pertanto una garanzia di stabilità e durevolezza nel tempo, idonee a qualunque impiego e ad ogni ambiente sia interno che esterno, dal più classico e raffinato, al più ampio e di intenso utilizzo.

• Per ottenere un ottimo risultato estetico è preferibile posare il materiale con una fuga di 2-3 mm utilizzando stuccature in tinta.

Ariostea si riserva di apportare modifiche senza preavviso ai prodotti, declinando ogni responsabilità per danni diretti o indiretti da eventuali modifiche.

Ultra Ariostea prevede un certo numero di facce differenti, a parità di prodotto, per creare una gradevole variabilità estetica nella posa. In fase di approntamento dell'ordine la selezione delle facce è random quindi la venatura continua tra i pezzi ordinati non è garantita.

Ultra è un prodotto derivante dalla combinazione della terra con il fuoco. La eventuale continuità di venatura tra un pezzo e l'altro è soggetta alla tolleranza tipica dei prodotti naturali.

• The processing of natural raw materials, combined with the use of leading-edge patented production techniques, makes it possible to obtain high-tech materials characterized by typical full-body effects, a feature that has always been the exclusive hallmark of quarried marble and stone.

• Chromatic variations, veining and speckling are thus prized characteristics of Ariostea materials, designed and produced to recreate the fascination of exclusive floorings, that reveal the randomness and beauty of natural materials. On the basis of the above statements, the colour references in the catalogues and samples are to be considered as approximate.

• The slabs of the High-Tech collections are realized with a 100% full body, a compact and frost-proof mass and they are resistant to chemical attacks. For this reason they are a guarantee of stability and durability in the time, suitable for whatever use and destination, both interior and exterior, from the more classic and refined, to the most spacious and of intense utilization one.

• For a better aesthetic result, is preferable to spread out the material with a 2-3 mm of joint, jointing with tone on tone colours.

Ariostea keeps the right to change all the mentioned items without notice and declining any responsibility for direct or indirect damage caused from these changes.

Ultra Ariostea, compared with an equal product, provides a number of different faces, to create a pleasant aesthetic variability in the laying. In the order preparation phase, the face selection is random and therefore the continuous veining between the ordered pieces is not guaranteed.

Ultra is a product derived from a combination of earth with fire. The continuous veining between pieces is subject to the typical variation of natural products.

• Die Umwandlung von natürlichen Rohmaterialien mit Hilfe von innovativen und patentierten Produktionstechnologien, ermöglicht die Herstellung von Materialien mit hoher technischer Leistungsfähigkeit, die sich durch die typischen vollgemischten Effekte unterscheiden und die seit jeher die charakteristische Besonderheit der Marmorarten und der Steine aus dem Steinbruch sind.

• Die farblichen Unterschiede, die Äderungen und die kleinen Punkte sind aus diesem Grund charakteristische Eigenschaften der Materialien Ariostea von besonderem Wert. Diese "Unvollkommenheiten" sind besonders gewollt, um einen exklusiven Bodenbelag zu erzielen, bei dem die Zufälligkeit und die Schönheit der natürlichen Materialien voll zum Ausdruck kommen können. Angesichts der oben aufgeführten Tatsache sind die Farben der Kataloge und der Muster unverbindlich.

• Die Platten der Kollektionen High-Tech werden in einziger, vollgemischter, kompakter, frost- und chemikalienbeständiger Masse hergestellt. Deshalb sind sie eine Garantie für Stabilität und Haltbarkeit im Laufe der Zeit, geeignet für jegliche Nutzung und für jedes Ambiente, sowohl für Innen- als Außenbereiche, von den

klassischsten und raffiniertesten, bis zu den größten mit intensiver Nutzung.

• Um eine optimale Ästhetik zu erreichen, es ist vorzuziehen, das Material mit einer Fuge von 2-3 mm zu verlegen und Verfügungen in ähnlichen Farbtönen zu verwenden.

Ariostea behält sich vor, ohne Ankündigung Änderungen an den Produkten vorzunehmen, und lehnt jede Haftung für direkte oder indirekte Schäden durch eventuelle Änderungen ab.

Ultra Ariostea - sieht eine gewisse Anzahl verschiedenartig gestalteter Oberflächen für dasselbe Produkt vor, um damit ansprechende ästhetische Variablen beim Verlegen erzielen zu können. Bei der Zusammenstellung der Bestellung wird die Auswahl der Oberflächen dem Zufall überlassen, sodass ein gleichförmiger Verlauf der Maserung zwischen den bestellten Stücken nicht gesichert ist. Ultra- ist ein Produkt, das aus dem Zusammenspiel von Erde und Feuer entstammt. Der eventuell kontinuierliche Verlauf der Maserung zwischen dem einem und dem anderen Stück unterliegt der typischen Toleranz von natürlichen Produkten.

• La transformation de matières premières naturelles, allée à l'application de technologies de production d'avant-garde brevetées, permet d'obtenir des matériaux capables de performances techniques élevées se distinguant par leurs effets pleine masse typiques qui sont depuis toujours la prérogative exclusive des marbres et des pierres de carrière.

• Les variations chromatiques, les veines et les petits points sont donc des caractéristiques de grande valeur des matériaux Ariostea, recherchées et voulues dans le but de recréer la suggestion d'un sol exclusif grâce auquel il est possible de redécouvrir l'impondérable et la splendeur des matériaux naturels. C'est la raison pour laquelle les références chromatiques présentées sur les catalogues et les échantillons ne sont données qu'à titre indicatif.

• Les dalles de les collections High Tech sont réalisées en une unique masse, compacte, résistante au gel et aux attaches chimiques. Ces dalles sont donc une garantie de stabilité et durabilité dans le temps, elles sont indiquées pour toute utilisation soit pour l'intérieur que l'extérieur, pour tous endroits de plus classique et raffiné au plus large et à grand passage.

• Pour obtenir un excellent résultat esthétique, est préférable de poser le matériau avec un joint de 2-3 mm utilisant le Jointoiment en couleurs ton sur ton.

Ariostea se réserve le droit d'apporter, sans préavis, des modifications aux produits, et décline toute responsabilité pour dommages directs ou indirects, des éventuelles modifications.

Ultra Ariostea prévoit un certain nombre de faces différentes, pour un même produit, pour créer une agréable variabilité esthétique dans la pose. En phase de préparation de la commande, la sélection des faces est aléatoire donc le grain continu entre les pièces commandées ne peut pas être garanti.

Ultra est un produit dérivé de la combinaison de la terre et du feu. La continuité éventuelle dans le grain entre une pièce et une autre est soumise à la tolérance typique des produits naturels.

SAFE SYSTEM

NORMA DIN 51130		R9 6° - 10°	R10 10° - 19°
COLLEZIONE / COLLECTION / KOLLEKTION / COLLECTION	FINITURA / FINISH / OBERFLÄCHENAUSFÜHRUNG / FINITION	COEFFICIENTE DI ATRITO NORMALE AVERAGE FRICTION COEFFICIENT NORMALER REIBUNGSKOEFFIZIENT COEFFICIENT DE FROTTEMENT MOYEN	
ULTRA MARMI	SOFT	R9	-
ULTRA IRIDIUM	SOFT	R9	-
ULTRA iCementi	SOFT	R9	-
ULTRA METAL	SOFT	R9	-
ULTRA PIETRE	SOFT	R9	-
ULTRA PIETRE	STRUCTURED	-	R10
ULTRA RESINE	SOFT	R9	-
ULTRA WOOD	SOFT	R9	-

N.B: I valori di resistenza allo scivolamento, coefficiente di attrito statico o dinamico, riportati sul catalogo e nella tabella Safe System sono da ritenersi puramente indicativi e non vincolanti. Ogni eventuale specifica necessità dovrà essere da noi confermata al momento dell'ordine e comunque sempre prima della posa.

ANM.: Die Werte für die Rutschfestigkeit, also des statischen oder dynamischen Reibungskoeffizienten, die im Katalog oder in der Tabelle Safe System aufgeführt sind, sind als unverbindliche Richtwerte anzusehen. Alle spezifischen Anforderungen müssen von uns bei der Bestellung und in jedem Fall vor der Verlegung immer bestätigt werden.

NB: Slip resistance values, coefficient of static or dynamic friction, in the catalog and in the Safe System Table are purely indicative and not binding. Any specific requirements must be confirmed by us at the time of ordering and in any case before installation.

NB: Les valeurs de résistance au glissement, le coefficient de frottement statique ou dynamique, indiqués sur le catalogue et sur le tableau Safe System (Système de Sécurité) doivent être considérés comme purement indicatifs et ne sauraient engager notre responsabilité. Toutes les éventuelles spécifications nécessaires devront faire l'objet d'une confirmation de notre part au moment de la commande et en tout état de cause avant la pose.

Classificazione secondo le norme CEN e ISO gruppo B1a-UGL EN 14411 All.G e ISO 13006 All.G /
 Classification in accordance with CEN and ISO standards B1a-UGL EN 14411 Enclosed G and ISO 13006 Encl. G /
 Klassifizierung gemäß CEN und ISO Normen Gruppe B1a-UGL EN 14411 Anl. G und ISO 13006 Anl.G /
 Classification selon les normes CEN et ISO groupe B1a-UGL EN 14411 P.J.G et ISO 13006 P.J.G



240

GRADO DI VARIAZIONE CROMATICA / DEGREE OF COLOUR CHANGE / GRAD DER FARBABWEICHUNG / DEGRE DE VARIATION CHROMATIQUE

V1 LOW
 PRODOTTO MONOCROMATICO
 MONOCHROMATIC PRODUCT
 EINFARBIGES PRODUKT
 PRODUIT MONOCHROMATIQUE

V2 MODERATE
 PRODOTTO CON LEGGERA VARIAZIONE CROMATICA
 PRODUCT WITH LIGHT CHROMATIC VARIATION
 PRODUKT MIT LEICHTER FARBNUANCE
 PRODUIT À LÉGERE VARIATION CHROMATIQUE

V3 HIGH
 PRODOTTO CON MARCATA VARIAZIONE CROMATICA
 PRODUCT WITH HIGH SHADE CHROMATIC VARIATION
 PRODUKT MIT AUSGEPRÄGTER FARBNUANCE
 PRODUIT À VARIATION CHROMATIQUE ACCENTUÉE

V4 EXTREME
 PRODOTTO CON FORTE VARIAZIONE CROMATICA
 PRODUCT WITH VERY HIGH SHADE CHROMATIC VARIATION
 PRODUKT MIT STARKER FARBNUANCE
 PRODUIT À FORTE VARIATION CHROMATIQUE

ULTRA MARMI





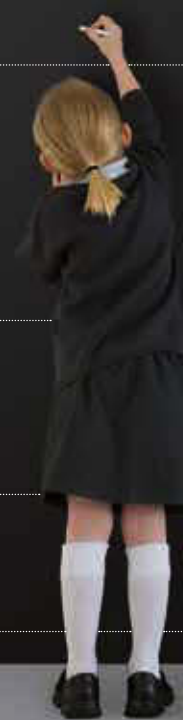





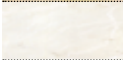





ARABESCATO STATUARIO	V3	TRAVERTINO SANTA CATERINA	V3
CREMA MARFIL	V2	ERAMOSIA BROWN	V3
ESTREMOZ	V2	ZEBRINO BLACK	V2
STATUARIO ALTISSIMO	V3	TRAVERTINO NAVONA	V2
PAONAZZETTO S	V3	BIANCO COVELANO	V3
STATUARIO ULTRA	V3	GRIS DE SAVOIE	V3
THASSOS	V2		

PROPRIETÀ CHIMICO - FISICHE / CHEMICAL - PHYSICAL PROPERTIES / CHEMISCH PHYSISCHE EIGENSCHAFTEN / PROPRIÉTÉS CHIMIQUES - PHYSIQUES	NORMA / REGULATION / NORMEN / NORME	VALORE PRESCRITTO / REQUIRED VALUE / VORGESCHRIEBENER WERT / VALUER PRESCRITE	VALORI MEDI ULTRA/ ULTRA AVERAGE VALUES / ULTRA DURCHSCHNITTSWERTE / VALEURS MOYENNES ULTRA
ASSORBIMENTO D'ACQUA WATER ABSORPTION / WASSERAUFNAHME / ABSORPTION D'EAU	ISO 10545-3	≤ 0,5 %	0,03% - 0,06% SUPERFICIE: / SURFACES: / OBERFLÄCHEN: / SURFACES: • SOFT • STRUTTURATO / STRUCTURED / STRUKTURIERT / STRUCTURÉ
DIMENSIONI SIZES / ABMESSUNGEN / DIMENSIONS	ISO 10545-2	± 0,6% max LUNGHEZZA E LARGHEZZA / LENGHT AND WIDTH / LÄNGE UND BREITE / LONGUEUR ET LARGEUR	± 0,1% LUNGHEZZA E LARGHEZZA / LENGHT AND WIDTH / LÄNGE UND BREITE / LONGUEUR ET LARGEUR
		± 5% max SPESSORE / THICKNESS / STÄRKE / EPAISSEUR	± 3% SPESSORE / THICKNESS / STÄRKE / EPAISSEUR
		± 0,5% max RETTILINEITÀ SPIGOLI / LINEARITY / KANTENGERADHEIT / RECTITUDE DES ARÊTES	± 0,1% RETTILINEITÀ SPIGOLI / LINEARITY / KANTENGERADHEIT / RECTITUDE DES ARÊTES
RESISTENZA ALL'ABRASIONE PROFONDA / DEEP ABRASION RESISTANCE / TIEFVERSCHLEISSBESTÄNDIGKEIT / RESISTANCE A L'ABRASION PROFONDE	ISO 10545-6	± 0,6% max ORTOGONALITÀ / WEDGING / RECHTWINKLIGKEIT / ORTHOGONALITÉ	± 0,1% ORTOGONALITÀ / WEDGING / RECHTWINKLIGKEIT / ORTHOGONALITÉ
		± 0,5% max PLANARITÀ / WARPAGE / EBENFLÄCHIGKEIT / PLANÉITÉ	± 0,2% PLANARITÀ / WARPAGE / EBENFLÄCHIGKEIT / PLANÉITÉ
RESISTENZA ALLE MACCHIE STAIN RESISTANCE / FLECKENBESTÄNDIGKEIT / RESISTANCE AUX TACHES	ISO 10545-14	METODO DI PROVA DISPONIBILE / TESTING METHOD AVAILABLE/ VERFÜGBARES PRÜFVERFAHREN/ MÉTHODE D'ESSAI DISPONIBLE	RESISTENTI ALLE MACCHIE / RESISTANT TO STAIN / FLECKENBESTÄNDIGKEIT / RESISTANTES AUX TACHES
RESISTENZA SBALZI TERMICI RESISTANCE TO THERMAL SHOCKS / TEMPERATURWECHSELBESTÄNDIGKEIT / RESISTANCE AUX ECARTS DE TEMPERATURE	ISO 10545-9	METODO DI PROVA DISPONIBILE / TESTING METHOD AVAILABLE/ VERFÜGBARES PRÜFVERFAHREN/ MÉTHODE D'ESSAI DISPONIBLE	RESISTENTE / RESISTANT / BESTÄNDIG / RESISTANT
RESISTENZA COLORI ALLA LUCE RESISTANCE TO LIGHT/LICHTBESTÄNDIGKEIT DER FARBEN/RESISTANCE DES COULEURS A LA LUMIERE	DIN 51094	NESSUN CAMPIONE DEVE PRESENTARE APPREZZABILI VARIAZIONI DI COLORE / NO SAMPLE MUST SHOW NOTICEABLE COLOUR CHANGE /KEIN EXEMPLAR SOLL SICHTBARE FARBVERÄNDERUNGEN AUFWEISEN / AUCUN ÉCHANTILLON NE DOIT PRÉSENTER DE VARIATIONS IMPORTANTES DES COULEURS	CAMPIONI INALTERATI IN BRILLANTEZZA E COLORE NO CHANGE IN BRIGHTNESS OR COLOUR / GLANZ UND FARBE DER MUSTER UNVERÄNDERT / ÉCHANTILLONS INCHANGÉS EN BRILLANCE ET COULEUR
DILATAZIONE TERMICA LINEARE COEFFICIENT OF LINEAR THERMAL EXPANSION / LINEARER WÄRMEAUSSDEHNUNGSKOEFFIZIENT / DILATATION THERMIQUE LINEAIRE	ISO 10545-8	METODO DI PROVA DISPONIBILE / TESTING METHOD AVAILABLE/ VERFÜGBARES PRÜFVERFAHREN/ MÉTHODE D'ESSAI DISPONIBLE	6 MK⁻¹
RESISTENZA AL GELO FROST RESISTANCE / FROSTBESTÄNDIGKEIT / RESISTANCE AU GEL	ISO 10545-12	NESSUN CAMPIONE DEVE PRESENTARE ROTTURE O ALTERAZIONI APPREZZABILI DELLA SUPERFICIE / NO SAMPLE MUST SHOW ALTERATIONS TO SURFACE / DIE MUSTER SOLLLEN WEDER BRUCH NOCH SCHÄDEN AN DER OBERFLÄCHE AUFWEISEN / AUCUN ÉCHANTILLON NE DOIT PRÉSENTER DE RUPTURES O D'ALTÉRATIONS CONSIDÉRABLES DE LA SURFACE	NON GELIVI / FROST PROOF / FROSTSICHER / NON GÉLIFS
RESISTENZA AI PRODOTTI CHIMICI RESISTANCE TO CHEMICAL PRODUCTS / CHEMIKALIENBESTÄNDIGKEIT / RESISTANCE AUX PRODUITS CHIMIQUES	ISO 10545-13	NESSUN CAMPIONE DEVE PRESENTARE ALTERAZIONI VISIBILI ALL'ATTACCO CHIMICO (ACIDI-BASI-SALI DA PISCINA) AD ESCLUSIONE DI PRODOTTI CONTENENTI ACIDO FLUORIDRICO ESUOI COMPOSTI/NO SAMPLE MUST SHOW VISIBLE SIGNS OF CHEMICAL ATTACK (ACIDS-BASIS-ADDITIVES FOR POOLS) EXCEPT FOR PRODUCTS CONTAINING HYDROFLUORIC ACID AND DERIVATES. / DIE MUSTER DÜRFEN KEINE SICHTBARE SPUREN INFOLGE CHEMISCHER EINWIRKUNG ZEIGEN (SÄUREN-BASEN-ZUSATZSTOFFE FÜR SCHWIMMBECKEN) MIT AUSNAHME DER PRODUKTE, DIE FLUORIDWASSERSTOFF UND DESSEN NEBENERZEUGNISSE ENTHALTEN./AUCUN ÉCHANTILLON NE DOIT PRÉSENTER D'ALTÉRATIONS VISIBLES D'ATTAQUE CHIMIQUE (ACIDES-BASES-ADDITIFS POUR PISCINE) SAUF LES PRODUITS QUI SONT COMPOSÉS AVEC DE L'ACIDE FLUORHYDRIQUE ET SES DÉRIVÉS.	CONFORME / CONFORMS / KONFORM / CONFORME
BRILLANTEZZA (LEVIGATI) BRIGHTNESS (POLISHED)/GLANZ (GESCHLIFFENE) / BRILLANT (POLIS)			MAGGIORE O UGUALE A QUELLA DEI MARMI E DEI GRANITI NATURALI, LEVIGATI O LUCIDATI / MORE OR EQUAL THAN NATURAL MARBLE AND GRANITE, POLISHED OR HONED / MINDESTENS SO DAUERHAFT WIE DER VON NATÜRLICHEM MARMOR UND GRANIT, SOWIE IN GESCHLIFFENER ODER GLÄNZENDER AUSFÜHRUNG / SUPÉRIEUR OU ÉGAL À CELUI DES MARBRES ET DES GRANITS NATURELS POLIS OU LÜSTRÉS
COEFFICIENTE DI ATTRITO FRICTION COEFFICIENT/REIBUNGSKOEFFIZIENT / COEFFICIENT DE FRICTION	DIN 51130		VEDERE I VALORI DEI SINGOLI MATERIALI NELLA COLLEZIONE ULTRA / SEE VALUES FOR SINGLE MATERIALS IN THE ULTRA COLLECTION / NEHMEN SIE EINSICHT IN DIE WERTE DER EINZELNEN MATERIALIEN DER KOLLEKTION ULTRA / CONSULTER LES VALEUS DE CHAQUE MATÉRIAU DANS LA COLLECTION ULTRA
	BCR		







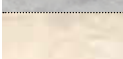

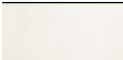
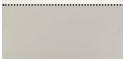
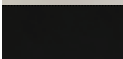
ULTRA ONICI ONICE GRIGIO V4 ONICE BIANCO EXTRA V4 ONICE BEIGE V4	ULTRA IRIIDIUM NERO V1 GRIGIO V1 BIANCO V1	ULTRA METAL BROWN ZINC V3 BLUE ZINC V3 GREY ZINC V3	ULTRA iCementi GRAPHITE V3 IRON V3 IVORY V3 SILVER V3 BRONZE V3	ULTRA PIETRE JERUSALEM LIMESTONE V2 AZUL BATEIG LIMESTONE V2 SAN VICENTE LIMESTONE V2 BASALTINA ANTRACITE V2 BASALTINA GREY V2 BASALTINA WHITE V2 BASALTINA SAND V2 BASALTINA MOKA V2	ULTRA RESINE EBANO V2 PIOMBO V2 SILICIO V2 CALCE V2	ULTRA WOOD NOCE AMERICANO V3 NOCE CHIARO V3 NOCE SCURO V3 NOCE OSSIDATO V3 NOCE CALCE V3
--	--	---	---	--	--	--

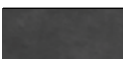
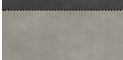
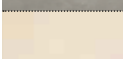

CODICI E FORMATI / CODES AND SIZES / ARTIKELNR. UND FORMATE / CODES ET FORMATS







ULTRA MARMİ	SPessore: / THICKNESS: / DICKE: / ÉPAISSEUR: 6 mm	FINITURA / FINISH / OBERFLÄCHENFUHRUNG / FINITION	300x150	300x100	150x100	150x150	100x100	150x75	75x75	75x37,5
			120"x60"	120"x40"	60"x40"	60"x60"	40"x40"	60"x30"	30"x30"	30"x15"
	CREMA MARFIL	SHINY	UM6L300304	UM6L310304	UM6L151304	UM6L150304	UM6L100304	UM6L157304	UM6L75304	UM6L37304
		SOFT	UM6S300304	UM6S310304	UM6S151304	UM6S150304	UM6S100304	UM6S157304	UM6S75304	UM6S37304
	ESTREMOZ	SHINY	UM6L300466	-	-	UM6L150466	-	UM6L157466	UM6L75466	UM6L37466
		SOFT	UM6S300466	-	-	UM6S150466	-	UM6S157466	UM6S75466	UM6S37466
	STATUARIO ALTISSIMO	SHINY	UM6L300441	-	-	UM6L150441	-	UM6L157441	UM6L75441	UM6L37441
		SOFT	UM6S300441	-	-	UM6S150441	-	UM6S157441	UM6S75441	UM6S37441
	STATUARIO ALTISSIMO A	SHINY	UM6L300441A	-	-	-	-	-	-	-
		SOFT	UM6S300441A	-	-	-	-	-	-	-
	STATUARIO ALTISSIMO B	SHINY	UM6L300441B	-	-	-	-	-	-	-
		SOFT	UM6S300441B	-	-	-	-	-	-	-
	Paonazetto S	SHINY	UM6L300382	-	-	UM6L150382	-	UM6L157382	UM6L75382	UM6L37382
		SOFT	UM6S300382	-	-	UM6S150382	-	UM6S157382	UM6S75382	UM6S37382
	STATUARIO ULTRA	SHINY	UM6L300260	-	-	UM6L150260	-	UM6L157260	UM6L75260	UM6L37260
		SOFT	UM6S300260	-	-	UM6S150260	-	UM6S157260	UM6S75260	UM6S37260
	STATUARIO ULTRA A	SHINY	UM6L300260A	-	-	-	-	-	-	-
		SOFT	UM6S300260A	-	-	-	-	-	-	-
	STATUARIO ULTRA B	SHINY	UM6L300260B	-	-	-	-	-	-	-
		SOFT	UM6S300260B	-	-	-	-	-	-	-
	THASSOS	SHINY	UM6L300318	UM6L310318	UM6L151318	UM6L150318	UM6L100318	UM6L157318	UM6L75318	UM6L37318
		SOFT	UM6S300318	UM6S310318	UM6S151318	UM6S150318	UM6S100318	UM6S157318	UM6S75318	UM6S37318
	TRAVERTINO SANTA CATERINA	SHINY	UM6L300431	-	-	UM6L150431	-	UM6L157431	UM6L75431	UM6L37431
		SOFT	UM6S300431	-	-	UM6S150431	-	UM6S157431	UM6S75431	UM6S37431
	ERAMOSIA BROWN	SHINY	UM6L300469	-	-	UM6L150469	-	UM6L157469	UM6L75469	UM6L37469
	ZEBRINO BLACK	SHINY	UM6L300465	-	-	UM6L150465	-	UM6L157465	UM6L75465	UM6L37465
	ARABESCATO STATUARIO	SHINY	-	-	-	UM6L150479	-	UM6L157479	UM6L75479	UM6L37479
		SOFT	-	-	-	UM6S150479	-	UM6S157479	UM6S75479	UM6S37479
	ARABESCATO STATUARIO A	SHINY	UM6L300479A	-	-	-	-	-	-	-
		SOFT	UM6S300479A	-	-	-	-	-	-	-
	ARABESCATO STATUARIO B	SHINY	UM6L300479B	-	-	-	-	-	-	-
		SOFT	UM6S300479B	-	-	-	-	-	-	-
	BIANCO COVELANO	SHINY	UM6L300480	-	-	UM6L150480	-	UM6L157480	UM6L75480	UM6L37480
		SOFT	UM6S300480	-	-	UM6S150480	-	UM6S157480	UM6S75480	UM6S37480
	GRIS DE SAVOIE	SHINY	UM6L300498	-	-	UM6L150498	-	UM6L157498	UM6L75498	UM6L37498
		SOFT	UM6S300498	-	-	UM6S150498	-	UM6S157498	UM6S75498	UM6S37498
	TRAVERTINO NAVONA	SHINY	UM6L300481	-	-	UM6L150481	-	UM6L157481	UM6L75481	UM6L37481
		SOFT	UM6S300481	-	-	UM6S150481	-	UM6S157481	UM6S75481	UM6S37481

ULTRA IRIDIUM	6 mm		300x150	300x100	150x100	150x150	100x100	150x75	75x75	75x37,5
			120"x60"	120"x40"	60"x40"	60"x60"	40"x40"	60"x30"	30"x30"	30"x15"
	BIANCO	SHINY	UI6L300353	UI6L310353	UI6L151353	UI6L150353	UI6L100353	UI6L157353	UI6L75353	-
		SOFT	UI6S300353	UI6S310353	UI6S151353	UI6S150353	UI6S100353	UI6S157353	UI6S75353	-
	GRIGIO	SHINY	UI6L300402	-	-	UI6L150402	-	UI6L157402	UI6L75402	-
		SOFT	UI6S300402	-	-	UI6S150402	-	UI6S157402	UI6S75402	-
	NERO	SHINY	UI6L300357	UI6L310357	UI6L151357	UI6L150357	UI6L100357	UI6L157357	UI6L75357	-
		SOFT	UI6S300357	UI6S310357	UI6S151357	UI6S150357	UI6S100357	UI6S157357	UI6S75357	-

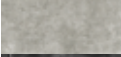

ULTRA iCementi	6 mm		300x150	300x100	150x100	150x150	100x100	150x75	75x75	75x37,5
			120"x60"	120"x40"	60"x40"	60"x60"	40"x40"	60"x30"	30"x30"	30"x15"
	GRAPHITE	SOFT	UC6S300421	UC6S310421	UC6S151421	UC6S150421	UC6S100421	UC6S157421	UC6S75421	UC6S37421
	IRON	SOFT	UC6S300422	UC6S310422	UC6S151422	UC6S150422	UC6S100422	UC6S157422	UC6S75422	UC6S37422
	IVORY	SOFT	UC6S300433	UC6S310433	UC6S151433	UC6S150433	UC6S100433	UC6S157433	UC6S75433	UC6S37433
	SILVER	SOFT	UC6S300420	UC6S310420	UC6S151420	UC6S150420	UC6S100420	UC6S157420	UC6S75420	UC6S37420
	BRONZE	SOFT	UC6S300434	UC6S310434	UC6S151434	UC6S150434	UC6S100434	UC6S157434	UC6S75434	UC6S37434

ULTRA ONICI	SPessore: / THICKNESS: / DICKE: / ÉPAISSEUR:		FINITURA / FINISH / OBERFLÄCHENAUFÜHRUNG / FINITION								
	6 mm		300x150 120"x60"	300x100 120"x40"	180x21,5 72"x8 ^{1/2} "	150x150 60"x60"	150x100 60"x40"	150x75 60"x30"	100x100 40"x40"	75x75 30"x30"	75x37,5 30"x15"
	ONICE GRIGIO	SHINY	UO6L300411	-	-	UO6L150411	-	UO6L157411	-	UO6L75411	UO6L37411
		SOFT	UO6S300411	-	-	UO6S150411	-	UO6S157411	-	UO6S75411	UO6S37411
	ONICE BIANCO EXTRA	SHINY	UO6L300400	-	-	UO6L150400	-	UO6L157400	-	UO6L75400	UO6L37400
		SOFT	UO6S300400	-	-	UO6S150400	-	UO6S157400	-	UO6S75400	UO6S37400
	ONICE BEIGE	SHINY	UO6L300401	-	-	UO6L150401	-	UO6L157401	-	UO6L75401	UO6L37401
		SOFT	UO6S300401	-	-	UO6S150401	-	UO6S157401	-	UO6S75401	UO6S37401

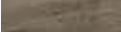
ULTRA METAL	6 mm		FINITURA / FINISH / OBERFLÄCHENAUFÜHRUNG / FINITION								
	6 mm		300x150 120"x60"	300x100 120"x40"	180x21,5 72"x8 ^{1/2} "	150x150 60"x60"	150x100 60"x40"	150x75 60"x30"	100x100 40"x40"	75x75 30"x30"	75x37,5 30"x15"
	BLUE ZINC	SOFT	UMT6S300499	-	-	UMT6S150499	-	UMT6S157499	-	UMT6S75499	UMT6S37499
		BROWN ZINC	SOFT	UMT6S300500	-	-	UMT6S150500	-	UMT6S157500	-	UMT6S75500
		GREY ZINC	SOFT	UMT6S300501	-	-	UMT6S150501	-	UMT6S157501	-	UMT6S75501

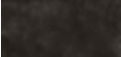
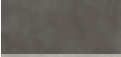
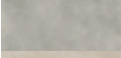
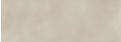
ULTRA PIETRE	6 mm		FINITURA / FINISH / OBERFLÄCHENAUFÜHRUNG / FINITION								
	6 mm		300x150 120"x60"	300x100 120"x40"	180x21,5 72"x8 ^{1/2} "	150x150 60"x60"	150x100 60"x40"	150x75 60"x30"	100x100 40"x40"	75x75 30"x30"	75x37,5 30"x15"
	JERUSALEM LIMESTONE	ST	-	UP6ST310462	-	-	UP6ST151462	-	UP6ST100462	-	-
		AZUL BATEIG LIMESTONE	ST	-	UP6ST310461	-	-	UP6ST151461	-	UP6ST100461	-
		SAN VICENTE LIMESTONE	ST	-	UP6ST310463	-	-	UP6ST151463	-	UP6ST100463	-
		BASALTINA ANTRACITE	SOFT	-	UP6S310442	-	-	UP6S151442	-	UP6S100442	-
		BASALTINA GREY	SOFT	-	UP6S310443	-	-	UP6S151443	-	UP6S100443	-
		BASALTINA WHITE	SOFT	-	UP6S310446	-	-	UP6S151446	-	UP6S100446	-
		BASALTINA SAND	SOFT	-	UP6S310445	-	-	UP6S151445	-	UP6S100445	-
		BASALTINA MOKA	SOFT	-	UP6S310444	-	-	UP6S151444	-	UP6S100444	-

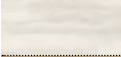
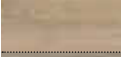
ULTRA RESINE	6 mm		FINITURA / FINISH / OBERFLÄCHENAUFÜHRUNG / FINITION								
	6 mm		300x150 120"x60"	300x100 120"x40"	180x21,5 72"x8 ^{1/2} "	150x150 60"x60"	150x100 60"x40"	150x75 60"x30"	100x100 40"x40"	75x75 30"x30"	75x37,5 30"x15"
	EBANO	PRL	-	UR6P310458	-	-	-	-	UR6P100458	-	-
		SOFT	-	UR6S310458	-	-	UR6S151458	-	UR6S100458	-	-
	PIOMBO	PRL	-	UR6P310459	-	-	-	-	UR6P100459	-	-
		SOFT	-	UR6S310459	-	-	UR6S151459	-	UR6S100459	-	-
	SILICIO	PRL	-	UR6P310460	-	-	-	-	UR6P100460	-	-
		SOFT	-	UR6S310460	-	-	UR6S151460	-	UR6S100460	-	-
	CALCE	PRL	-	UR6P310457	-	-	-	-	UR6P100457	-	-
		SOFT	-	UR6S310457	-	-	UR6S151457	-	UR6S100457	-	-

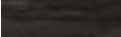
ULTRA WOOD	6 mm		FINITURA / FINISH / OBERFLÄCHENAUFÜHRUNG / FINITION								
	6 mm		300x150 120"x60"	300x100 120"x40"	180x21,5 72"x8 ^{1/2} "	150x150 60"x60"	150x100 60"x40"	150x75 60"x30"	100x100 40"x40"	75x75 30"x30"	75x37,5 30"x15"
	NOCE AMERICANO	SOFT	-	-	UW6S180493	-	-	-	-	-	-
		NOCE CALCE	SOFT	-	-	UW6S180494	-	-	-	-	-
		NOCE CHIARO	SOFT	-	-	UW6S180495	-	-	-	-	-
		NOCE OSSIDATO	SOFT	-	-	UW6S180496	-	-	-	-	-
		NOCE SCURO	SOFT	-	-	UW6S180497	-	-	-	-	-



PACKAGING

ULTRA®

ARIOSTEA® HIGHTECH

320 X 160

300 X 150

300 X 100

POICHÈ L'ORDINE È PREPARATO **"SU MISURA"**,
ANCHE L'IMBALLO È **"SU MISURA"**





AS THE ORDER IS **"TAILOR MADE"**, THE PACKAGING IS ALSO **"TAILOR MADE"**
DA DIE BESTELLUNG **"NACH MASS"** VORBEREITET WURDE, IST AUCH DIE VERPACKUNG **"MASSGEFERTIG"**
PARCE QUE L'ORDRE EST PRÉPARÉ **"SUR MESURE"**, L'EMBALLAGE EST LUI AUSSI **"SUR MESURE"**

245

OTTIMIZZIAMO PER VOI L'IMBALLO

WE OPTIMISE THE PACKAGING FOR YOU
WIR OPTIMIEREN FÜR SIE DIE VERPACKUNG
NOUS OPTIMISONS L'EMBALLAGE POUR VOUS

COSTO IMBALLI / COST OF PACKAGING / VERPACKUNGSKOSTEN / COÛT DE L'EMBALLAGE		
Cassa / Crate / Kiste / Caisse	300x150	125,00 €
Cassa / Crate / Kiste / Caisse	300x100	125,00 €
Cassa / Crate / Kiste / Caisse	150x150	125,00 €
Cassa Alta / Tall Crate / Hohe Kiste / Caisse Haute	-	59,50 €
Cassa Bassa / Short Crate / Niedrige Kiste / Caisse Basse	-	49,50 €
Cavalletto Grande / Large Stand / Großer Ständer / Grand Chevalet	-	200,00 €
Cavalletto Piccolo / Small Stand / Kleiner Ständer / Petit Chevalet	-	150,00 €

IMBALLO Cassa di legno PACKAGING Crate in wood VERPACKUNG Holz-kiste EMBALLAGE Caisse en Bois		FORMATO lastre in cm FORMAT slabs in cm FORMAT platten in cm FORMAT dalles en cm	PEZZI capienza max ITEMS max capacity FORMAT maximales fassungsvermögen PIÈCES capacité maximale	SCATOLE capienza max BOXES max capacity STÜCKZAHL maximales fassungsvermögen BOÎTES capacité maximale
	<p>CASSA CON INTERFALDA 300x150: Ingombro: 322 x 163 x h.34 cm Peso: 117 kg</p> <p>Crate with padding layers 300x150: Size: 322 x 163 x 34(H) cm Weight: 117 kg</p> <p>Kiste mit Zwischenlage 300x150: Platzbedarf: 322 x 163 x H 34 cm Gewicht: 117 kg</p> <p>Caisse avec intercalaire 300x150 : Encombrement : 322 x 163 x h. 34 cm Poids : 117 kg</p>	300x150	12	-
	<p>CASSA CON INTERFALDA 300x100: Ingombro: 325 x 113 x h.37 cm Peso: 104 kg</p> <p>Crate with padding layers 300x100: Size: 325 x 113 x 37(H) cm Weight: 104 kg</p> <p>Kiste mit Zwischenlage 300x100: Platzbedarf: 325 x 113 x H 37 cm Gewicht: 104 kg</p> <p>Caisse avec intercalaire 300x100 : Encombrement : 325 x 113 x h. 37 cm Poids : 104 kg</p>	300x100	16	-
	<p>CASSA CON INTERFALDA 150x150: Ingombro: 172 x 163 x h.41 cm Peso: 68 kg</p> <p>Crate with padding layers 150x150: Size: 172 x 163 x 41(H) cm Weight: 68 kg</p> <p>Kiste mit Zwischenlage 150x150: Platzbedarf: 172 x 163 x H 41 cm Gewicht: 68 kg</p> <p>Caisse avec intercalaire 150x150 : Encombrement : 172 x 163 x h. 41 cm Poids : 68kg</p>	150x150	24	-
	<p>CASSA ALTA: Ingombro: 171 x 112 x h.65 cm / Peso: 72 kg CASSA BASSA: Ingombro: 171 x 112 x h.40 cm / Peso: 54 kg</p> <p>Tall crate: Size: 171 x 112 x 65(H) cm / Weight: 72 kg Short crate: Size: 171 x 112 x 40(H) cm / Weight: 54 kg</p> <p>Hohe Kiste: Platzbedarf: 171 x 112 x H 65 cm / Gewicht: 72 kg Niedrige Kiste: Platzbedarf: 171 x 112 x H 40 cm / Gewicht: 54 kg</p> <p>Caisse haute : Encombrement : 171 x 112 x h. 65 cm / Poids : 72 kg Caisse basse : Encombrement : 171 x 112 x h. 40 cm / Poids : 54 kg</p> <p>PALLET: Ingombro / Size / Platzbedarf / Encombrement : 165 x 108 x h.15,5 cm</p>	150x100 cassa alta tall crate Hohe Kiste caisse haute 150x100 cassa bassa short crate Niedrige Kiste caisse basse 150x100 pallet	40 18 8	40 18 8

VERPACKUNG NACH MASS GEFERTIGT





IN DER TABELLE IST DER MAXIMALE INHALT PRO VERPACKUNG AUFGEFÜHRT



EMBALLAGE SUR MESURE

LE TABLEAU ILLUSTRE LE CONTENU MAXIMAL PAR EMBALLAGE

<p>Mq capienza max SQ.M. max capacity QM maximales fassungsvermögen m² capacité maximale</p>	<p>Kg (peso lordo) capienza max Kg (Gross weight) max capacity Kg (Bruttogewicht) maximales fassungsvermögen Kg (Poids brut) capacité maximale</p>	<p>NOTE NOTES ANMERKUNGEN NOTES</p>	
54,00	876,80	<ul style="list-style-type: none"> - ordine minimo 2 lastre per cassa; - non sono ammessi più di 6 articoli (codici) differenti per cassa; carico su camion: - sovrapposibilità max. su camion n. 6 casse; - max. 24 casse su camion (4 spazi) compatibilmente con i limiti di peso totale; - possibilità di affiancare a ciascuna pila nr. 2 europallet; - minimum order: 2 slabs per crate; - no more than 6 items (codes) per crate allowed; loading on lorry: - stack max. 6 crates on lorry; - max. 24 crates on lorry (4 spaces) within total weight limits; - option of placing 2 euro-pallets next to each stack; 	<ul style="list-style-type: none"> - Mindestbestellmenge 2 Platten pro Kiste ; - Es sind nicht mehr als 6 verschiedene Artikel (Art.-Nr.) pro Kiste zulässig; Ladung auf LKW: - Max. Stapelbarkeit auf LKW 6 Kisten; - Max. 24 Kisten pro LKW (4 Bereiche) unter Berücksichtigung des zulässigen Gesamtgewichts; - Möglichkeit, neben jeden Stapel 2 europallet; - commande minimale 2 dalles par caisse ; - pas plus de 6 articles (codes) différents par caisse ; chargement sur camion : - superposition max. par camion : 6 caisses ; - max. 24 caisses max par camion (4 espaces) compatibles avec les limites de poids total ; - possibilité d'accoler à chaque pile 2 euro palettes ;
48,00	779,40	<ul style="list-style-type: none"> - ordine minimo 3 lastre per cassa; - non sono ammessi più di 6 articoli (codici) differenti per cassa; carico su camion: - sovrapposibilità max. su camion n. 5 casse; - max. 32 casse su camion (8 spazi) compatibilmente con i limiti di peso totale; - possibilità di affiancare le casse l'una all'altra; - minimum order: 3 slabs per crate; - no more than 6 items (codes) per crate allowed; loading on lorry: - stack max. 5 crates on lorry; - max. 32 crates on lorry (8 spaces) within total weight limits; - option of placing crates next to each other; 	<ul style="list-style-type: none"> - Mindestbestellmenge 3 Platten pro Kiste; - Es sind nicht mehr als 6 verschiedene Artikel (Art.-Nr.) pro Kiste zulässig; Ladung auf LKW: - Max. Stapelbarkeit auf LKW 5 Kisten; - Max. 32 Kisten pro LKW (8 Bereiche) unter Berücksichtigung des zulässigen Gesamtgewichts; - Möglichkeit, die Kisten nebeneinander zu stellen; - commande minimale 3 dalles par caisse ; - pas plus de 6 articles (codes) différents par caisse ; chargement sur camion : - superposition max. par camion : 5 caisses ; - max. 32 caisses max par camion (8 espaces) compatibles avec les limites de poids total ; - possibilité d'accoler les caisses l'une à l'autre ;
54,00	827,80	<ul style="list-style-type: none"> - ordine minimo 4 lastre per cassa; - in ciascuna cassa il numero di lastre per articolo deve sempre essere pari; - non sono ammessi più di 6 articoli (codici) differenti per cassa; carico su camion: - sovrapposibilità max. su camion n. 5 casse; - max. 28 casse su camion (7 spazi) compatibilmente con i limiti di peso totale; - possibilità di affiancare a ciascuna pila nr. 1 europallet; - minimum order: 4 slabs per crate; - each crate must always contain an even number of slabs per item; - no more than 6 items (codes) per crate allowed; loading on lorry: - stack max. 5 crates on lorry; - max. 28 crates on lorry (7 spaces) within total weight limits; - option of placing 1 euro-pallet next to each stack; 	<ul style="list-style-type: none"> - Mindestbestellmenge 4 Platten pro Kiste; - In jeder Kiste muss die Anzahl der Platten pro Artikel immer eine gerade Zahl sein; - Es sind nicht mehr als 6 verschiedene Artikel (Art.-Nr.) pro Kiste zulässig; Ladung auf LKW: - Max. Stapelbarkeit auf LKW 5 Kisten; - Max. 28 Kisten pro LKW (7 Bereiche) unter Berücksichtigung des zulässigen Gesamtgewichts; - Möglichkeit, neben jeden Stapel Nr. 1 europallet; - commande minimale 4 dalles par caisse ; - dans chaque caisse, le nombre de dalles par articles doit toujours être pair ; - pas plus de 6 articles (codes) différents par caisse ; chargement sur camion : - superposition max. par camion : 5 caisses ; - max. 28 caisses max par camion (7 espaces) compatibles avec les limites de poids total ; - possibilité d'accoler à chaque pile 1 euro palette ;
60,00 27,00 12,00	916,20 433,90 189,00	<ul style="list-style-type: none"> - ordine minimo 2 scatole (= 2 lastre); - ordine tassativo multipli di 2 lastre / scatole; - una cassa alta / bassa o un pallet non possono contenere articoli (codici) differenti; carico su camion: - sovrapposibilità max. su camion n. 3 casse alte; - max. 30 casse alte su camion (15 spazi) compatibilmente con i limiti di peso totale; - minimum order: 2 boxes (= 2 slabs); - each crate must always contain an even number of slabs/boxes; - a tall/short crate or pallet may not contain different items (codes); loading on lorry: - stack max. 3 tall crates on lorry; - max. 30 tall crates on lorry (15 spaces) within total weight limits; 	<ul style="list-style-type: none"> - Mindestbestellmenge 2 Schachteln (= 2 Platten); - Bestellungen unbedingt Vielfache von 2 Platten/Schachteln; - In einer hohen/niedrigen Kiste oder einer Palette können nicht verschiedene Artikel (Art.-Nr.) enthalten sein; Ladung auf LKW: - Max. Stapelbarkeit auf LKW 3 hohe Kisten; - Max. 30 Kisten pro LKW (15 Bereiche) unter Berücksichtigung des zulässigen Gesamtgewichts; - commande minimale 2 boîtes (= 2 dalles) ; - commande totale multiples de 2 dalles/boîtes ; - une caisse haute / basse ou une palette ne peuvent pas contenir des articles (codes) différents ; chargement sur camion : - superposition max. par camion 3 caisses hautes ; - max. 30 caisses hautes max par camion (15 espaces) compatibles avec les limites de poids total ;





<p>Imballo Cassa di legno PACKAGING Crate in wood VERPACKUNG Holz-kiste EMBALLAGE Caisse en Bois</p>		<p>FORMATO lastre in cm FORMAT slabs in cm FORMAT platten in cm FORMAT dalles en cm</p>	<p>PEZZI capienza max ITEMS max capacity FORMAT maximales fassungsvermögen PIÈCES capacité maximale</p>	<p>SCATOLE capienza max BOXES max capacity STÜCKZAHL maximales fassungsvermögen BOÎTES capacité maximale</p>
	<p>CASSA ALTA: Ingombro: 201 x 132 x h.45 cm / Peso: 100 kg CASSA BASSA: Ingombro: 201 x 132 x h.34 cm / Peso: 53,50 kg Tall crate: Size: 201 x 132 x 45(H) cm / Weight: 100 kg Short crate: Size: 201 x 132 x 34(H) cm / Weight: 53,50 kg Hohe Kiste: Platzbedarf: 201 x 132 x H 45 cm / Gewicht: 100 kg Niedrige Kiste: Platzbedarf: 201 x 132 x H 34 cm / Gewicht: 53,50 kg Caisse haute : Encombrement : 201 x 132 x h. 45 cm / Poids : 100 kg Caisse basse : Encombrement : 201 x 132 x h. 34 cm / Poids : 53,50 kg</p>	<p>180x21,5 cassa alta tall crate Hohe Kiste caisse haute</p> <p>180x21,5 cassa bassa short crate Niedrige Kiste caisse basse</p>	<p>140</p> <p>60</p>	<p>35</p> <p>15</p>
	<p>CASSA ALTA: Ingombro: 172 x 89 x h.65 cm / Peso: 59 kg CASSA BASSA: Ingombro: 172 x 89 x h.41 cm / Peso: 47 kg Tall crate: Size: 172 x 89 x 65(H) cm / Weight: 59 kg Short crate: Size: 172 x 89 x 41(H) cm / Weight: 47 kg Hohe Kiste: Platzbedarf: 172 x 89 x H 65 cm / Gewicht: 59 kg Niedrige Kiste: Platzbedarf: 172 x 89 x H 41 cm / Gewicht: 47 kg Caisse haute : Encombrement : 172 x 89 x h. 65 cm / Poids : 59 kg Caisse basse : Encombrement : 172 x 89 x h. 41 cm / Poids : 47 kg PALLET: Ingombro / Size / Platzbedarf / Encombrement : 165 x 85,5 x h.15,5 cm</p>	<p>150x75 cassa alta tall crate Hohe Kiste caisse haute</p> <p>150x75 cassa bassa short crate Niedrige Kiste caisse basse</p> <p>150x75 pallet</p>	<p>52</p> <p>24</p> <p>12</p>	<p>26</p> <p>12</p> <p>6</p>
	<p>CASSA ALTA: Ingombro: 172 x 89 x h.65 cm / Peso: 59 kg CASSA BASSA: Ingombro: 172 x 89 x h.41 cm / Peso: 47 kg Tall crate: Size: 172 x 89 x 65(H) cm / Weight: 59 kg Short crate: Size: 172 x 89 x 41(H) cm / Weight: 47 kg Hohe Kiste: Platzbedarf: 172 x 89 x H 65 cm / Gewicht: 59 kg Niedrige Kiste: Platzbedarf: 172 x 89 x H 41 cm / Gewicht: 47 kg Caisse haute : Encombrement : 172 x 89 x h. 65 cm / Poids : 59 kg Caisse basse : Encombrement : 172 x 89 x h. 41 cm / Poids : 47 kg PALLET: Ingombro / Size / Platzbedarf / Encombrement : 165 x 85,5 x h.15,5 cm</p>	<p>75x75 cassa alta tall crate Hohe Kiste caisse haute</p> <p>75x75 cassa bassa short crate Niedrige Kiste caisse basse</p> <p>75x75 pallet</p>	<p>114</p> <p>54</p> <p>27</p>	<p>38</p> <p>18</p> <p>9</p>
	<p>CASSA ALTA: Ingombro: 172 x 89 x h.65 cm / Peso: 59 kg CASSA BASSA: Ingombro: 172 x 89 x h.41 cm / Peso: 47 kg Tall crate: Size: 172 x 89 x 65(H) cm / Weight: 59 kg Short crate: Size: 172 x 89 x 41(H) cm / Weight: 47 kg Hohe Kiste: Platzbedarf: 172 x 89 x H 65 cm / Gewicht: 59 kg Niedrige Kiste: Platzbedarf: 172 x 89 x H 41 cm / Gewicht: 47 kg Caisse haute : Encombrement : 172 x 89 x h. 65 cm / Poids : 59 kg Caisse basse : Encombrement : 172 x 89 x h. 41 cm / Poids : 47 kg PALLET: Ingombro / Size / Platzbedarf / Encombrement : 165 x 85,5 x h.15,5 cm</p>	<p>75x37,5 cassa alta tall crate Hohe Kiste caisse haute</p> <p>75x37,5 cassa bassa short crate Niedrige Kiste caisse basse</p> <p>75x37,5 pallet</p>	<p>264</p> <p>120</p> <p>60</p>	<p>44</p> <p>20</p> <p>10</p>

VERPACKUNG NACH MASS GEFERTIGT
IN DER TABELLE IST DER MAXIMALE INHALT PRO VERPACKUNG AUFGEFÜHRT

EMBALLAGE SUR MESURE

LE TABLEAU ILLUSTRE LE CONTENU MAXIMAL PAR EMBALLAGE

<p>Mq capienza max SQ.M. max capacity QM maximales fassungsvermögen m² capacité maximale</p>	<p>Kg (peso lordo) capienza max Kg (Gross weight) max capacity Kg (Bruttogewicht) maximales fassungsvermögen Kg (Poids brut) capacité maximale</p>	<p>NOTE NOTES ANMERKUNGEN NOTES</p>	
<p>54,18</p> <p>23,22</p>	<p>832,30</p> <p>380,20</p>	<p>- ordine minimo 1 scatola (= 4 lastre); - una cassa alta / bassa o un pallet non possono contenere articoli (codici) differenti; carico su camion: - sovrapposibilità max. su camion n. 3 casse alte; - max. 30 casse alte su camion (15 spazi) compatibilmente con i limiti di peso totale;</p> <p>- minimum order: 1 box (= 4 slabs); - a tall/short crate or pallet may not contain different items (codes); loading on lorry: - stack max. 3 tall crates on lorry; - max. 30 tall crates on lorry (15 spaces) within total weight limits;</p>	<p>- Mindestbestellmenge 1 Schachtel (= 4 Platten); - In einer hohen/niedrigen Kiste oder einer Palette können nicht verschiedene Artikel (Art.-Nr.) enthalten sein; Ladung auf LKW: - Max. Stapelbarkeit auf LKW 3 hohe Kisten; - Max. 30 Kisten pro LKW (15 Bereiche) unter Berücksichtigung des zulässigen Gesamtgewichts;</p> <p>- commande minimale 1 boîte (= 4 dalles); - une caisse haute / basse ou une palette ne peuvent pas contenir des articles (codes) différents; chargement sur camion: - superposition max. par camion 3 caisses hautes; - max. 30 caisses hautes max par camion (15 espaces) compatibles avec les limites de poids total;</p>
<p>58,50</p> <p>27,00</p> <p>13,50</p>	<p>882,10</p> <p>426,90</p> <p>210,95</p>	<p>- ordine minimo 1 scatola (= 2 lastre); - una cassa alta / bassa o un pallet non possono contenere articoli (codici) differenti; carico su camion: - sovrapposibilità max. su camion n. 3 casse alte; - max. 30 casse alte su camion (15 spazi) compatibilmente con i limiti di peso totale;</p> <p>- minimum order: 1 box (= 2 slabs); - a tall/short crate or pallet may not contain different items (codes); loading on lorry: - stack max. 3 tall crates on lorry; - max. 30 tall crates on lorry (15 spaces) within total weight limits;</p>	<p>- Mindestbestellmenge 1 Schachtel (= 2 Platten); - In einer hohen/niedrigen Kiste oder einer Palette können nicht verschiedene Artikel (Art.-Nr.) enthalten sein; Ladung auf LKW: - Max. Stapelbarkeit auf LKW 3 hohe Kisten; - Max. 30 Kisten pro LKW (15 Bereiche) unter Berücksichtigung des zulässigen Gesamtgewichts;</p> <p>- commande minimale 1 boîte (= 2 dalles); - une caisse haute / basse ou une palette ne peuvent pas contenir des articles (codes) différents; chargement sur camion: - superposition max. par camion 3 caisses hautes; - max. 30 caisses hautes max par camion (15 espaces) compatibles avec les limites de poids total;</p>
<p>64,13</p> <p>30,38</p> <p>15,19</p>	<p>961,31</p> <p>474,50</p> <p>234,73</p>	<p>- ordine minimo 1 scatola (= 3 lastre); - una cassa alta / bassa o un pallet non possono contenere articoli (codici) differenti; carico su camion: - sovrapposibilità max. su camion n. 3 casse alte; - max. 30 casse alte su camion (15 spazi) compatibilmente con i limiti di peso totale;</p> <p>- minimum order: 1 box (= 3 slabs); - a tall/short crate or pallet may not contain different items (codes); loading on lorry: - stack max. 3 tall crates on lorry; - max. 30 tall crates on lorry (15 spaces) within total weight limits;</p>	<p>- Mindestbestellmenge 1 Schachtel (= 3 Platten); - In einer hohen/niedrigen Kiste oder einer Palette können nicht verschiedene Artikel (Art.-Nr.) enthalten sein; Ladung auf LKW: - Max. Stapelbarkeit auf LKW 3 hohe Kisten; - Max. 30 Kisten pro LKW (15 Bereiche) unter Berücksichtigung des zulässigen Gesamtgewichts;</p> <p>- commande minimale 1 boîte (= 3 dalles); - une caisse haute / basse ou une palette ne peuvent pas contenir des articles (codes) différents; chargement sur camion: - superposition max. par camion 3 caisses hautes; - max. 30 caisses hautes max par camion (15 espaces) compatibles avec les limites de poids total;</p>
<p>74,25</p> <p>33,75</p> <p>16,88</p>	<p>1103,70</p> <p>521,90</p> <p>258,50</p>	<p>- ordine minimo 1 scatola (= 6 lastre); - una cassa alta / bassa o un pallet non possono contenere articoli (codici) differenti; carico su camion: - sovrapposibilità max. su camion n. 3 casse alte; - max. 30 casse alte su camion (15 spazi) compatibilmente con i limiti di peso totale;</p> <p>- minimum order: 1 box (= 6 slabs); - a tall/short crate or pallet may not contain different items (codes); loading on lorry: - stack max. 3 tall crates on lorry; - max. 30 tall crates on lorry (15 spaces) within total weight limits;</p>	<p>- Mindestbestellmenge 1 Schachtel (= 6 Platten); - In einer hohen/niedrigen Kiste oder einer Palette können nicht verschiedene Artikel (Art.-Nr.) enthalten sein; Ladung auf LKW: - Max. Stapelbarkeit auf LKW 3 hohe Kisten; - Max. 30 Kisten pro LKW (15 Bereiche) unter Berücksichtigung des zulässigen Gesamtgewichts;</p> <p>- commande minimale 1 boîte (= 6 dalles); - une caisse haute / basse ou une palette ne peuvent pas contenir des articles (codes) différents; chargement sur camion: - superposition max. par camion 3 caisses hautes; - max. 30 caisses hautes max par camion (15 espaces) compatibles avec les limites de poids total;</p>

<p>Imballo Cassa di legno PACKAGING Crate in wood VERPACKUNG Holz-kiste EMBALLAGE Caisse en Bois</p>		<p>FORMATO lastre in cm FORMAT slabs in cm FORMAT platten in cm FORMAT dalles en cm</p>	<p>PEZZI capienza max ITEMS max capacity FORMAT maximales fassungsvermögen PIÈCES capacité maximale</p>	<p>SCATOLE capienza max BOXES max capacity STÜCKZAHL maximales fassungsvermögen BOÎTES capacité maximale</p>
	<p>CASSA ALTA: Ingombro: 121 x 112 x h.65 cm / Peso: 55 kg CASSA BASSA: Ingombro: 121 x 112 x h.41 cm / Peso: 44 kg Tall crate: Size: 121 x 112 x 65(H) cm / Weight: 55 kg Short crate: Size: 121 x 112 x 41(H) cm / Weight: 44 kg Hohe Kiste: Platzbedarf: 121 x 112 x H 65 cm / Gewicht: 55 kg Niedrige Kiste: Platzbedarf: 121 x 112 x H 41 cm / Gewicht: 44 kg Caisse haute : Encombrement : 121 x 112 x h. 65 cm / Poids : 55 kg Caisse basse : Encombrement : 121 x 112 x h. 41 cm / Poids : 44 kg PALLET: Ingombro / Size / Platzbedarf / Encombrement : 120 x 110 x h.15,5 cm</p>	<p>100x100 cassa alta tall crate Hohe Kiste caisse haute</p> <p>100x100 cassa bassa short crate Niedrige Kiste caisse basse</p> <p>100x100 pallet</p>	<p>52</p> <p>24</p> <p>12</p>	<p>26</p> <p>12</p> <p>6</p>
	<p>CAVALLETTO DA 50 LASTRE: Ingombro: 312 x 74 x h.191 cm Peso: 227 kg Rack for 50 slabs: Size: 312 x 74 x 191(H) cm Weight: 227 kg Gestell mit 50 Platten: Platzbedarf: 312 x 74 x H 191 cm Gewicht: 227 kg Chevalet 50 dalles : Encombrement : 312 x 74 x h. 191 cm Poids : 227 kg</p>	<p>300x150</p>	<p>50</p>	<p>-</p>
	<p>CAVALLETTO DA 50 LASTRE: Ingombro: 312 x 74 x h.140 cm Peso: 180 kg Rack for 50 slabs: Size: 312 x 74 x 140(H) cm Weight: 180 kg Gestell mit 50 Platten: Platzbedarf: 312 x 74 x H 140 cm Gewicht: 180 kg Chevalet 50 dalles : Encombrement : 312 x 74 x h. 140 cm Poids : 180 kg</p>	<p>300x100</p>	<p>50</p>	<p>-</p>
	<p>CAVALLETTO DA 24 LASTRE: Ingombro: 312 x 70 x h.191 cm Peso: 194 kg Rack for 24 slabs: Size: 312 x 70 x 191(H) cm Weight: 194 kg Gestell mit 24 Platten: Platzbedarf: 312 x 70 x H 191 cm Gewicht: 194 kg Chevalet 24 dalles : Encombrement : 312 x 70 x h. 191 cm Poids : 194 kg</p>	<p>300x150</p>	<p>24</p>	<p>-</p>

<p>Imballo Cassa di legno PACKAGING Crate in wood VERPACKUNG Holz-kiste EMBALLAGE Caisse en Bois</p>		<p>FORMATO lastre in cm FORMAT slabs in cm FORMAT platten in cm FORMAT dalles en cm</p>	<p>PEZZI capienza max ITEMS max capacity FORMAT maximales fassungsvermögen PIÈCES capacité maximale</p>	<p>SCATOLE capienza max BOXES max capacity STÜCKZAHL maximales fassungsvermögen BOÎTES capacité maximale</p>
	<p>CAVALLETTO DA 48 LASTRE: Ingombro: 161 x 74 x h.191 cm Peso: 85 kg</p> <p>Rack for 48 slabs: Size: 161 x 74 x 191(H) cm Weight: 85 kg</p> <p>Gestell 48 Platten: Platzbedarf: 161 x 74 x H 191 cm Gewicht: 85 kg</p> <p>Chevalet 48 dalles : Encombrement : 161 x 74 x h. 191 cm Poids : 85 kg</p>	<p>150x150 cavalletto 48 lastre rack 48 slabs Gestell 48 Platten chevalet 48 dalles</p>	<p>48</p>	<p>-</p>

CONTAINER

252

	<p>CONTAINER 40 PIEDI (11,90 x 2,33 x h.2,35 m)*</p> <ul style="list-style-type: none"> - nr. 18 casse 300x150; - nr. 30 casse 300x100 + nr. 5 casse 150x150; - nr. 30 casse 300x100 + nr. 6 casse alte 75x37,5\75x75\150x75; - nr. 30 casse 300x100 + nr. 6 casse alte 100x100; - nr. 30 casse 300x100 + nr.10 casse alte 150x100; - nr. 35 casse 150x150 (compatibilmente con il peso); - nr. 40 casse 201x132; <p>* Per quanto riguarda i formati 100x100 o 75x37,5\75x75\150x75 il calcolo deve tenere conto del peso (non si occupa mai tutto lo spazio a disposizione poiché si eccederebbero i limiti di peso).</p> <p>40 FOOT CONTAINER (11.90 x 2.33 x 2.35 (h) m)*</p> <ul style="list-style-type: none"> - 18 crates 300x150; - 30 crates 300x100 + 5 crates 150x150; - 30 crates 300x100 + 6 tall crates 75x37.5\75x75\150x75; - 30 crates 300x100 + 6 tall crates 100x100; - 30 crates 300x100 + 10 tall crates 150x100; - 35 tall crates 150x150 (within weight limits); - 40 crates 201x132; <p>* Concerning the 100x100 or 75x37.5\75x75\150x75 formats, calculation must take weight into account (the space is never completely filled as weight would be exceeded).</p>	<p>40 FUSS-CONTAINER (11,90 x 2,33 x H 2,35 m)*</p> <p>Art.-Nr. 18 Kisten 300x150; Art.-Nr. 30 Kisten 300x100 + 5 Kisten 150x150; Art.-Nr. 30 Kisten 300x100 + 6 hohe Kisten 75x37,5\75x75\150x75; Art.-Nr. 30 Kisten 300x100 + 6 hohe Kisten 100x100; Art.-Nr. 30 Kisten 300x100 + 10 hohe Kisten 150x100; Art.-Nr. 35 Kisten 150x150 (unter Berücksichtigung des Gewichts); Art.-Nr. 40 Kisten 201x132;</p> <p>* Was die Formate 100x100 oder 75x37,5\75x75\150 betrifft, muss das Gewicht in der Berechnung berücksichtigt werden (es wird nie der gesamte verfügbare Platz ausgenutzt, da dadurch die Gewichtsgrenzen überschritten werden würden).</p> <p>CONTAINER 40 PIEDS (11,90 x 2,33 x h. 2,35 m)*</p> <ul style="list-style-type: none"> - nbre. 18 caisses 300x150 ; - nbre. 30 caisses 300x100 + nbre. 5 caisses 150x150 ; - nbre. 30 caisses 300x100 + nbre. 6 caisses hautes 75x37,5\75x75\150x75 ; - nbre. 30 caisses 300x100 + nbre. 6 caisses hautes 100x100 ; - nbre. 30 caisses 300x100 + nbre. 10 caisses hautes 150x100 ; - nbre. 35 caisses hautes 150x150 (compatibles avec le poids) ; - nbre. 40 caisses 201x132; <p>* Concernant les formats 100x100 ou 75x37,5\75x75\150, le calcul doit tenir compte du poids (on n'occupe jamais tout l'espace à disposition, car cela dépasserait les limites de poids).</p>
	<p>CONTAINER 20 PIEDI (5,90x2,32xh. 2,35 m)</p> <ul style="list-style-type: none"> - nr. 6 casse 300x150; - nr. 10 casse 300x100 + nr. 5 casse 150x150; - nr. 10 casse 300x100 + nr. 5 casse alte 240x120; - nr. 10 casse 300x100 + nr. 10 casse alte 150x100; - nr. 10 casse 300x100 + nr. 6 casse alte 75x37,5\75x75\150x75; - nr. 10 casse 300x100 + nr. 12 casse alte 100x100; - nr. 15 casse 150x150 + nr. 3 casse alte 75x37,5\75x75\150x75; - nr. 24 casse alte 100x100 (compatibilmente con il peso); - nr. 18 casse alte 75x37,5\75x75\150x75; - nr. 18 casse alte 150x100; - nr. 19 casse 201x132. <p>20 FOOT CONTAINER (5.90x2.32x2.35(H) m)</p> <ul style="list-style-type: none"> - 6 crates 300x150; - 10 crates 300x100 + 5 crates 150x150; - 10 crates 300x100 + 5 tall crates 240x120; - 10 crates 300x100 + 10 tall crates 150x100; - 10 crates 300x100 + 6 tall crates 75x37.5\75x75\150x75; - 10 crates 300x100 + 12 tall crates 100x100; - 15 crates 150x150 + 3 tall crates 75x37.5\75x75\150x75; - 24 tall crates 100x100 (within weight limits); - 18 tall crates 75x37.5\75x75\150x75; - 18 tall crates 150x100; - 19 crates 201x132. 	<p>20 FUSS-CONTAINER (5,90 x 2,32 x H 2,35 m)</p> <p>Art.-Nr. 6 Kisten 300x150; Art.-Nr. 10 Kisten 300x100 + 5 Kisten 150x150; Art.-Nr. 10 Kisten 300x100 + 5 hohe Kisten 240x120; Art.-Nr. 10 Kisten 300x100 + 10 hohe Kisten 150x100; Art.-Nr. 10 Kisten 300x100 + 6 hohe Kisten 75x37,5\75x75\150x75; Art.-Nr. 10 Kisten 300x100 + 12 hohe Kisten 100x100; Art.-Nr. 15 Kisten 150x150 + 3 hohe Kisten 75x37,5\75x75\150x75; Art.-Nr. 24 hohe Kisten 100x100 (unter Berücksichtigung des Gewichts); Art.-Nr. 18 hohe Kisten 75x37,5\75x75\150x75; Art.-Nr. 18 hohe Kisten 150x100; Art.-Nr. 19 Kisten 201x132.</p> <p>CONTAINER 20 PIEDS (5,90 x 2,32 x h. 2,35 m)</p> <ul style="list-style-type: none"> - nbre. 6 caisses 300x150 ; - nbre. 10 caisses 300x100 + nbre. 5 caisses 150x150 ; - nbre. 10 caisses 300x100 + nbre. 5 caisses hautes 240x120 ; - nbre. 10 caisses 300x100 + nbre. 10 caisses hautes 150x100 ; - nbre. 10 caisses 300x100 + nbre. 6 caisses hautes 75x37,5\75x75\150x75 ; - nbre. 10 caisses 300x100 + nbre. 12 caisses hautes 100x100 ; - nbre. 15 caisses 150x150 + nbre. 3 caisses hautes 75x37,5\75x75\150x75 ; - nbre. 24 caisses hautes 100x100 (compatibles avec le poids) ; - nbre. 18 caisses hautes 75x37,5\75x75\150x75 ; - nbre. 18 caisses hautes 150x100; - nbre. 19 caisses 201x132.

VERPACKUNG NACH MASS GEFERTIGT

IN DER TABELLE IST DER MAXIMALE INHALT PRO VERPACKUNG AUFGEFÜHRT

EMBALLAGE SUR MESURE

LE TABLEAU ILLUSTRE LE CONTENU MAXIMAL PAR EMBALLAGE

Mq capienza max SQ.M. max capacity QM maximales fassungsvermögen m² capacité maximale	Kg (peso lordo) capienza max Kg (Gross weight) max capacity Kg (Bruttogewicht) maximales fassungsvermögen Kg (Poids brut) capacité maximale	NOTE NOTES ANMERKUNGEN NOTES	
108,00	1604,60	- un cavalletto può contenere max. 5 articoli (codici) differenti; - il cavalletto deve essere riempito per la massima capacità indicata; - one rack may contain up 5 different items (codes); - the rack must be filled to the maximum capacity specified;	- Ein Gestell kann max. 5 verschiedene Artikel (Art.-Nr.) beinhalten; - Das Gestell muss für das angegebene max. Fassungsvermögen gefüllt werden; - un chevalet peut contenir au max. 5 articles (codes) différents ; - le chevalet doit être rempli selon la capacité maximale indiquée ;

NOTE

- Per la **sovrapponibilità di casse alte e basse** della medesima dimensione occorre rispettare il limite di altezza massima della pila pari a 2,10 m, tenendo presente che il carrello elevatore per il carico dei container non può sollevarsi oltre 1,40 m all'interno del container stesso.
- Il peso di casse e cavalletti è suscettibile di variazioni sensibili in base allo stato di umidità al momento della misurazione del peso;
- carico su camion: l'indicazione del numero massimo di casse è riferito ad un pianale unico di 13,6 x 2,45 m, compatibilmente con il peso; per camion di dimensioni differenti occorre riformulare il calcolo sulla base dello spazio e del volume delle casse;
- Carico su camion: per la sovrapposizione di casse alte e basse non oltrepassare l'altezza max. del numero di casse alte indicate per ciascun formato;
- Imballo in casse alte / basse / pallet: a parità di articolo (codice) ordinato, le casse vengono via via riempite secondo l'imballo di massima capienza (es: ordine 90 mq articolo XYZ in formato 150x75 cm sarà imballato con nr. 1 cassa alta contenente 58,5 mq + nr. 1 cassa alta per 31,5 mq);
- Reso delle casse: Il cliente avrà la facoltà di restituire le casse addebitate in fattura, franco stabilimento Ariostea. Personale autorizzato accerterà lo stato delle casse rese e compilerà il modulo di reso esclusivamente per le casse integre e complete dei quattro dischi metallici (bulldog) posti su ciascun angolo. Non possono essere resi né cavalletti, né pallet.

NOTE

- Concerning the **stackability of tall and short crates** of the same size, the maximum stack height of 2.10 m, should be respected, bearing in mind that the lift truck for loading the container cannot lift above 1.40 m inside the container itself.
- The weight of the crates and racks is subject to significant variations based on the moisture content at the time the weight was measured;
- Loading on lorry: the specified maximum number of crates refers to a single 13.6 x 2.45 m platform, within weight limits; for lorries of different sizes, calculation must be made based on the space and volume of the crates;
- Loading on lorry: to stack tall and short crates, do not exceed the maximum height for the number of tall crates specified for each format;
- Packaging in pallets/tall/short crates: for the same item (code) ordered, the crates are gradually filled according to the package of maximum capacity (e.g.: an order of 90 sq.m. of item XYZ in format 150 x 75 cm will be packaged in 1 tall crate containing 58.5 sq.m. + 1 tall crate containing 31.5 sq.m.);
- Crate return: the customer will have the option of returning the crates billed on the invoice, ex-factory Ariostea. Authorised employees will check the conditions of the returned crates and will fill out the return form, exclusively for undamaged crates that include the four toothed metal discs placed on each corner. Racks and pallets cannot be returned.

Anmerkungen

- Was die **Stapelbarkeit von hohen und niedrigen Kisten** mit der gleichen Abmessung angeht, muss die max. Höhe des Stapels von 2,10 m eingehalten werden, wobei zu berücksichtigen ist, dass der Gabelstapler zum Laden der Container im Inneren des Containers nicht über 1,40 m angehoben werden kann.
- Das Gewicht der Kisten und Gestelle ist auf Grundlage der Feuchtigkeit zum Zeitpunkt der Gewichtsmessung merklichen Schwankungen unterworfen;
- Ladung auf LKW: Die Angabe der max. Anzahl an Kisten bezieht sich auf eine 13,6 x 2,45 m große Plattform, unter Berücksichtigung des Gewichts; für LKWs in anderen Größen ist die Berechnung auf Grundlage des Raums und des Volumens der Kisten neu anzustellen;
- Ladung auf LKW: Was die Stapelbarkeit von hohen und niedrigen Kisten angeht, die max. Höhe der für jedes Format angegebenen hohen Kisten nicht überschreiten;
- Verpackung in hohen/niedrigen Kisten/Paletten: Bei gleichem bestellten Artikel (Art.-Nr.) werden die Kisten nach und nach gemäß der Verpackung mit dem höchsten Fassungsvermögen befüllt (Bsp.: Bestellung 90 m² Artikel XYZ im Format 150x75 cm wird in eine hohe Kiste mit 58,5 m² + 1 hohe Kiste mit 31,5 m² verpackt);
- Rückgabe der Kisten: Der Kunde hat die Möglichkeit, die Kisten, die ihm verrechnet wurden, frei Werk von Ariostea zurückzugeben. Autorisiertes Personal wird den Zustand der zurückgegebenen Kisten prüfen und ausschließlich für die unversehrten und mit den vier Metallscheiben (Bulldogs), die sich in jeder Ecke befinden, versehenen Kisten das Rückgabeformular ausfüllen. Es können weder Gestelle noch Paletten zurückgegeben werden.

NOTES

- Pour la **superposition des caisses hautes et basses** de la même dimension, il faut respecter la limite de hauteur maximale de la pile égale à 2,10 m, en tenant compte que le chariot élévateur pour le chargement des containers ne peut pas s'élever au-delà de 1,40 m à l'intérieur du container.
- Le poids des caisses et des chevalets peut sensiblement varier selon l'humidité au moment de la mesure du poids;
- Chargement sur camion: l'indication du nombre maximal de caisses se réfère à une plate-forme de 13,6 x 2,45 m, compatible avec le poids; pour des camions de différentes dimensions, il faudra refaire le calcul selon l'espace et le volume des caisses;
- Chargement sur camion: pour la superposition de caisses hautes et basses, ne pas dépasser la hauteur maximale du nombre de caisses hautes indiquées pour chaque format;
- Emballage dans les caisses hautes / basses / palettes: pour le même article (code) commandé, les caisses doivent être remplies au fur et à mesure selon l'emballage de capacité maximale (par ex: la commande 90 m² article XYZ en format 150x75 cm sera emballée avec 1 caisse haute de 58,5 m² + 1 caisse haute de 31,5 m²);
- Retour des caisses: le client pourra restituer les caisses facturées, franco usine Ariostea. Le personnel autorisé s'assurera de l'état des caisses retournées et remplira le formulaire de retour uniquement pour les caisses en parfait état et accompagnées des quatre disques métalliques (bulldog) placés sur chaque angle. Les chevalets et les palettes ne peuvent pas être retournés.

ARIOSTEAGREENROOM



Progettare il GreenRoom è stata per me l'occasione di sperimentare nuove applicazioni delle grandi superfici ceramiche che la tecnologia Ultra offre e di studiare l'incontro tra materiali lontani come vetro e ceramica.

L'area dedicata allo showroom, spogliata delle superfetazioni del passato, si è presentata nella sua forma più semplice in cui una grande quantità di situazioni strutturali differenti hanno fornito la grammatica essenziale per un nuovo linguaggio di geometrie e volumi.

Al fine di creare una stimolante esperienza espositiva e di ricavare spazi in equilibrio e continuità tra loro, ho sfruttato la moltitudine di pilastri presenti nelle due ali del palazzo inscrivendoli in portali di superfici variabili. Attraverso il loro susseguirsi ogni area tematica si mantiene in contatto

con il progetto nel suo insieme. I due anonimi porticati che affiancavano i percorsi principali, una volta ricongiunti al volume interno, sono stati trasformati in cannocchiali espositivi con la duplice funzione di filtro e collegamento visivo con il garden esterno.

In considerazione della genesi simmetrica dell'edificio e delle aree adiacenti, ho trovato opportuno trasporre il concetto di incontro anche nel grande salone centrale dove è stato collocato l'ingresso principale, oltrepassato il quale si intuisce immediatamente lo sviluppo dei due rami che qui confluiscono dando origine ad una scenografia frontale in cui il contatto tra natura e materia trova la sua massima espressione, fondendo la luce naturale e quella artificiale.

Architetto Marco Porpora





256





Design the Greenroom was the opportunity for me to experiment new applications of large ceramic surfaces offered by Ultra technology and to study the encounter between different materials as glass and ceramics.

The showroom area, deprived of past traces, in its simplest structure, with a large amount of different structural situations, provided the essential grammar for a new language of shapes and volumes.

In order to create an inspiring exhibition experience and to protect areas equilibrium and continuity, I took advantage of the two wings pillar multitude of the building inscribing them into variable surface gates. Each thematic area, through this sequence, keep connection with the whole project.

Two anonymous colonnades following the main routes, once rejoined to the internal volume, have been turned into exhibition telescopes with the dual function of filtering and visually relating the outside garden.

In consideration of the building and adjacent areas symmetrical genesis, I've wanted to transpose the encounter concept even in the wide central room where is placed the main entrance, beyond which is immediately perceptible the beginning of two route branches that come together here to create a frontal stage where nature and material contact is in its highest expression, melting natural and artificial light.

Architect Marco Porpora

ARIOSTEA®

HEADQUARTER

CASTELLARANO
REGGIO EMILIA
ITALY





www.ultra.ariostea.it
www.ariostea.it

Ariostea_via Cimabue 20
42014 Castellarano
Reggio Emilia - Italy

Tel. +39 0536 816811
Fax +39 0536 816838 (Italy)
Fax +39 0536 816858 (Export)

Numero Verde
800-214252 info@ariostea.it

CREDITS

Art direction: Marco Porpora, Mirco Natalini Marketing Ariostea
Graphic project: up-comunicazione.com

CAT01830
Printed in Italy - Edition 02 January 2016

Ariostea all right reserved

WWW.ARIOSTEA.IT **Ariostea**.via Cimabue 20 42014 Castellarano Reggio Emilia - Italy - Tel. +39 0536 816811 - Fax +39 0536 816838 (Italy) - Fax +39 0536 816858 (Export)