

# NOORD

*Amsterdam piers*



## Our values/

### **Made in Italy**

Selezioniamo le migliori materie prime e, secondo canoni estetici e funzionali, le trasformiamo in prodotti che interpretano con creatività il gusto italiano. Utilizziamo in uguale misura passione e tecnologia, cura del dettaglio e precisione, chimica e cultura, estetica e attenzione all'ambiente. Per noi Made in Italy è racchiudere tutto questo in ogni singolo prodotto.

### **Made in Italy**

*We pick the very best raw materials and we follow aesthetics and functional criteria to turn them into products embodying Italian taste and excellence. We sharply combine passion and technology, creativity and accuracy, science and culture, and environmental friendliness. To all of us, Made in Italy means gathering these features into every single product.*

### **Greenthinking**

Recuperiamo il 100% dell'acqua, autoproduciamo il 65% dell'energia, differenziamo il 98% dei rifiuti. Siamo stati i primi del settore ceramico a ottenere la certificazione PEF e tra i primi a guadagnarci l'EPD, la FDES e la HPDC. La maggior parte dei nostri prodotti è compatibile con lo standard LEED - Leadership in Energy and Environmental Design. Questo per noi è Greenthinking: un promessa molto seria, un impegno quotidiano.

### **Greenthinking**

*We recycle 100% of our water, produce 65% of our energy, separate 98% of our waste. We were the first company in the ceramic industry to obtain PEF certification and were among the first to earn the EPD, the FDES, and the HPDC certifications. The majority of our products comply with the LEED - Leadership in Energy and Environmental Design - standard. Greenthinking implies a solemn promise, an everyday commitment.*

GRES PORCELLANATO  
PORCELAIN STONEWARE

---

**Effetto cemento**  
*Concrete effect*

**NOORD**  
*Amsterdam piers*



## ISPIRAZIONE/ INSPIRATION

### **Industrial chic**

Noord è l'Europa industriale. È un viaggio nel design in continuo sviluppo, dal carattere inusuale e dalla verve visionaria. Dove darsene e zone industriali diventano incubatori formativi o ricreativi. Dove mix di spazi espositivi e concept store alloggiano in strutture d'avanguardia. E dove un materiale immancabile, il cemento, trova contaminazioni metalliche con cui marcare nuove calligrafie architettoniche.

### **Industrial chic**

*Noord means industrial Europe, a journey into continually evolving design with attitude and visionary verve. Where docks and industrial zones meld into educational or recreational areas of innovation. Where a mix of exhibition spaces and concept stores find a place among avant-garde buildings. And where a necessary material, cement, blends with metallic fibers, making architectural marks that form a lasting, decorative calligraphy, written into the finish.*

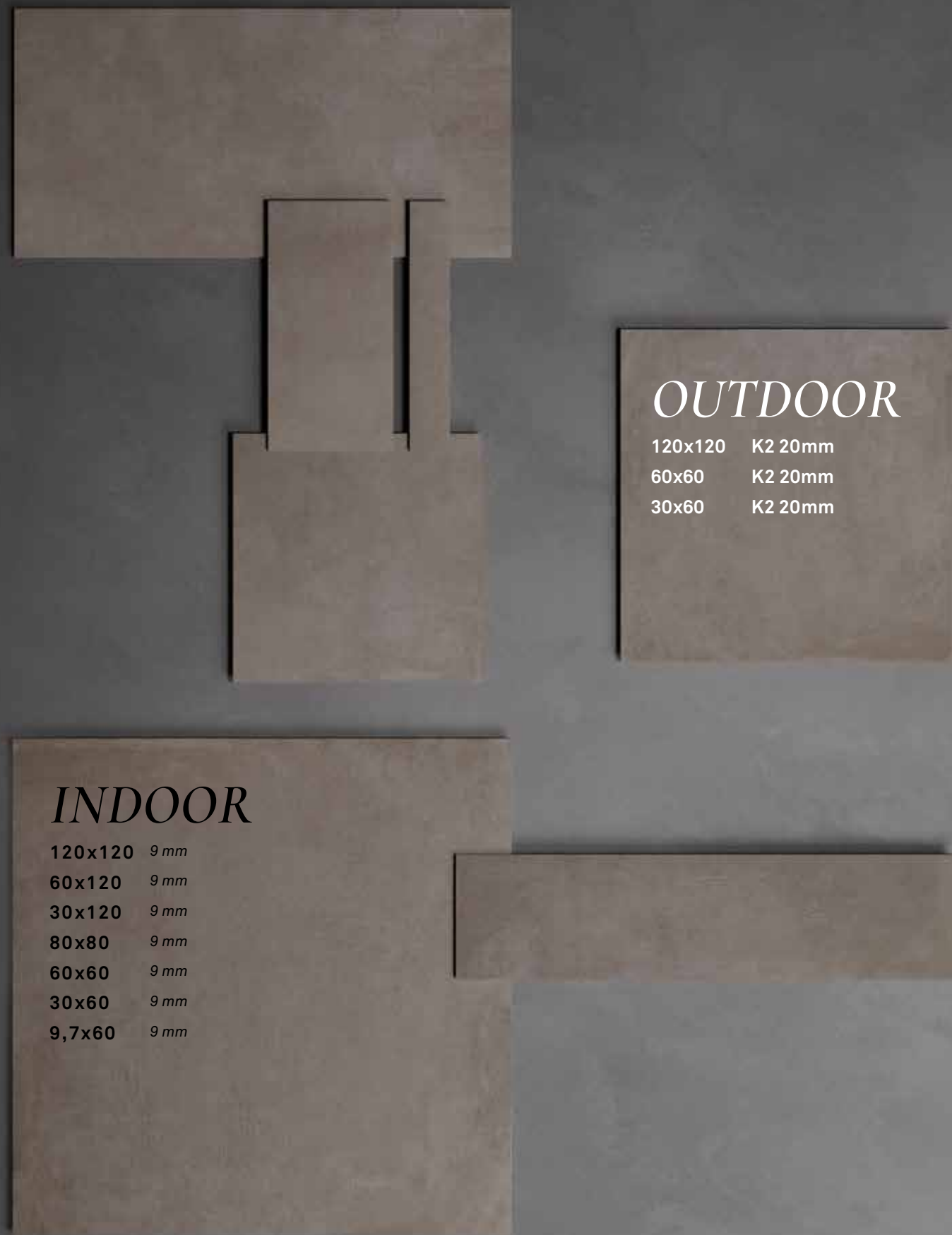

## INDOOR

120x120 9 mm  
60x120 9 mm  
30x120 9 mm  
80x80 9 mm  
60x60 9 mm  
30x60 9 mm  
9,7x60 9 mm

## OUTDOOR

120x120 K2 20mm  
60x60 K2 20mm  
30x60 K2 20mm

### Formati e spessori

Innovazione e comfort passano attraverso i sette formati di Noord in una sequenza - da 120x120 a 9,7x60 cm - calibrata per adeguarsi a ogni progetto. Tra le misure, tre si presentano anche in versione K2, il classico spessore di 2 cm resistente a qualunque agente esterno.

**10**  
FORMATI/  
SIZES

**2**  
SPESSORI/  
THICKNESSES

### Sizes and thicknesses

*Innovative and industrial Noord comes in seven sizes - from 120x120 to 9.7x60 cm - in a sequence calibrated to adapt to each kind of ceramic project. Among the sizes, three of them also come in the K2 variant - the classic 2cm - thick size resistant to any external agent.*



## 5 COLORI/ COLORS

## 2 SUPERFICI/ SURFACES

### Colori e superfici

La palette toni di Noord - Grey, Taupe, Anthracite, Gold e White - marca con misura lo spirito camaleontico dell'effetto cemento avanguardista. Le superfici matt vantano la nuova finitura Natural R10: il grip deciso ma morbido per interni dà il meglio in questa collezione, la cui resistenza all'usura e alle alterazioni atmosferiche si combina ai tratti estetici dell'interior design più riuscito.

### Colors and surfaces

*Noord's palette of tones - Grey, Taupe, Anthracite, Gold and White - identifies with the chameleon-like spirit of the avant-garde cement effect, able to blend with a multitude of environments. The matt surfaces boast the new, rich, Natural R10 finish. Its resistance to wear and weather changes merges with the aesthetic traits of the most successful indoor solutions.*



# anthracite

60x120 (24"x48") - 30x120 (12"x48")



noord anthracite



60X120 (24"x48")

noord antracite

60x120 (24"x48") - DECORO DOCKS 30x60 (12"x24") - BACCHETTA BRASS 0,8x30 (25/64"x12")  
LAVELLO A COLONNA / COLUMN SINK HOME DECOR 50x50x85 (20"x20"x33<sup>3</sup>/<sub>8</sub>")

---



noord anthracite

60x120 (24"x48") - 30x120 (12"x48")

---



grey

80x80 (32"x32")

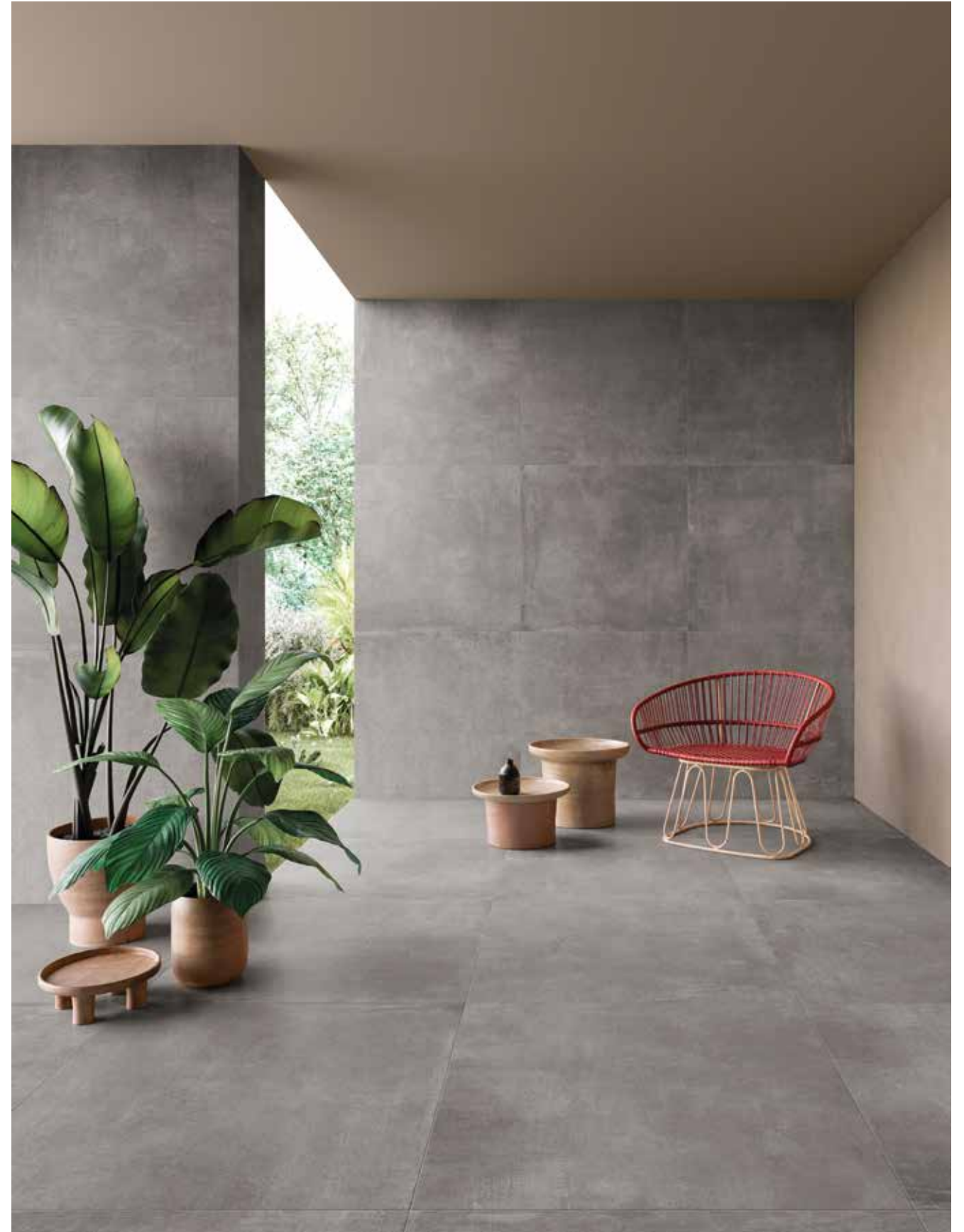

noord grey



80x80 (32"x32")

80x80 (32"x32")

120x120 (48"x48") **K2** 20 mm -  
DECORO DOCKS 30x60 (12"x24") -  
BACCHETTA BRASS 0,8x30 (25/64"x12")

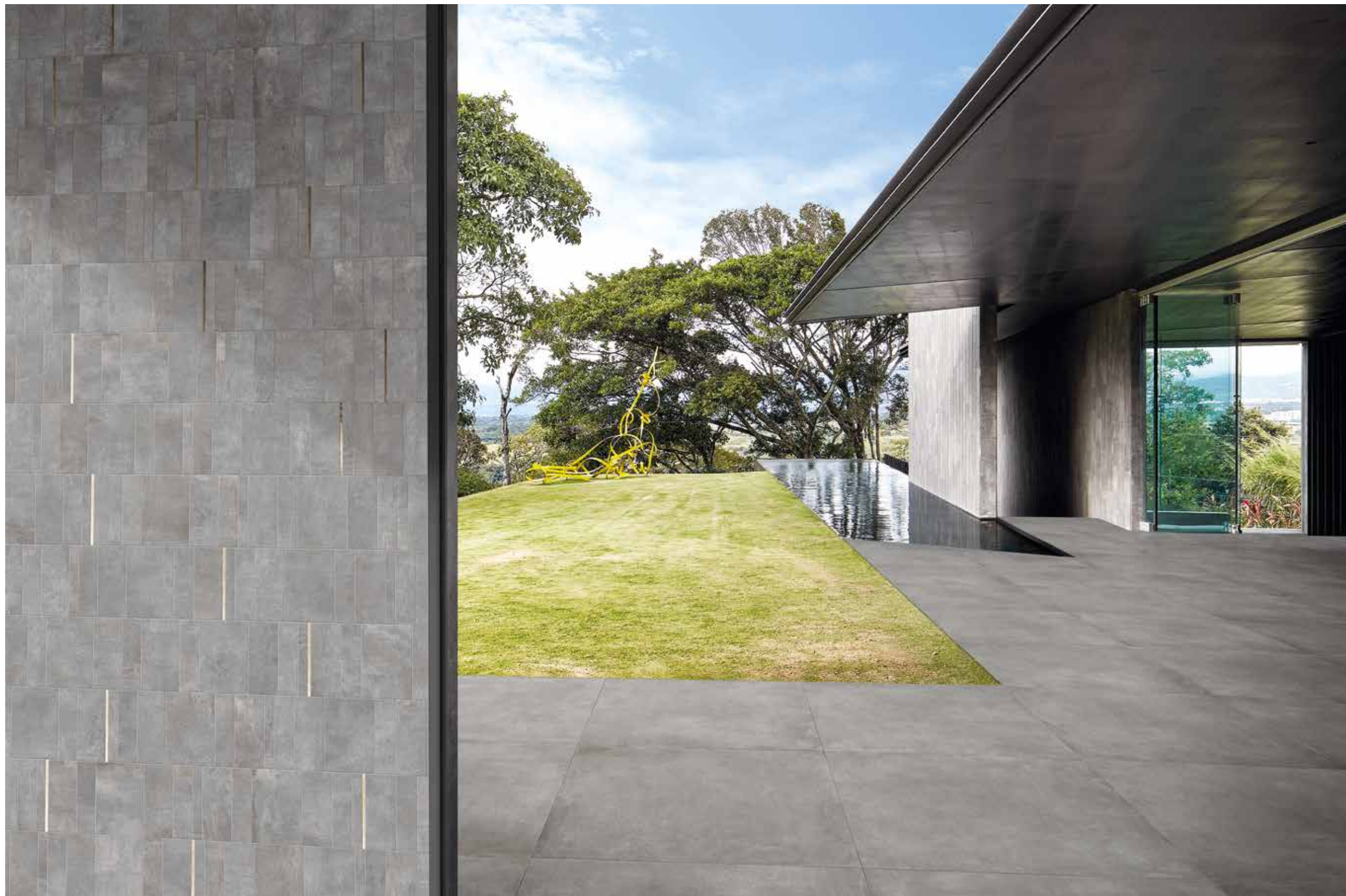

noord grey

# taupe

120x120 (48"x48")

---

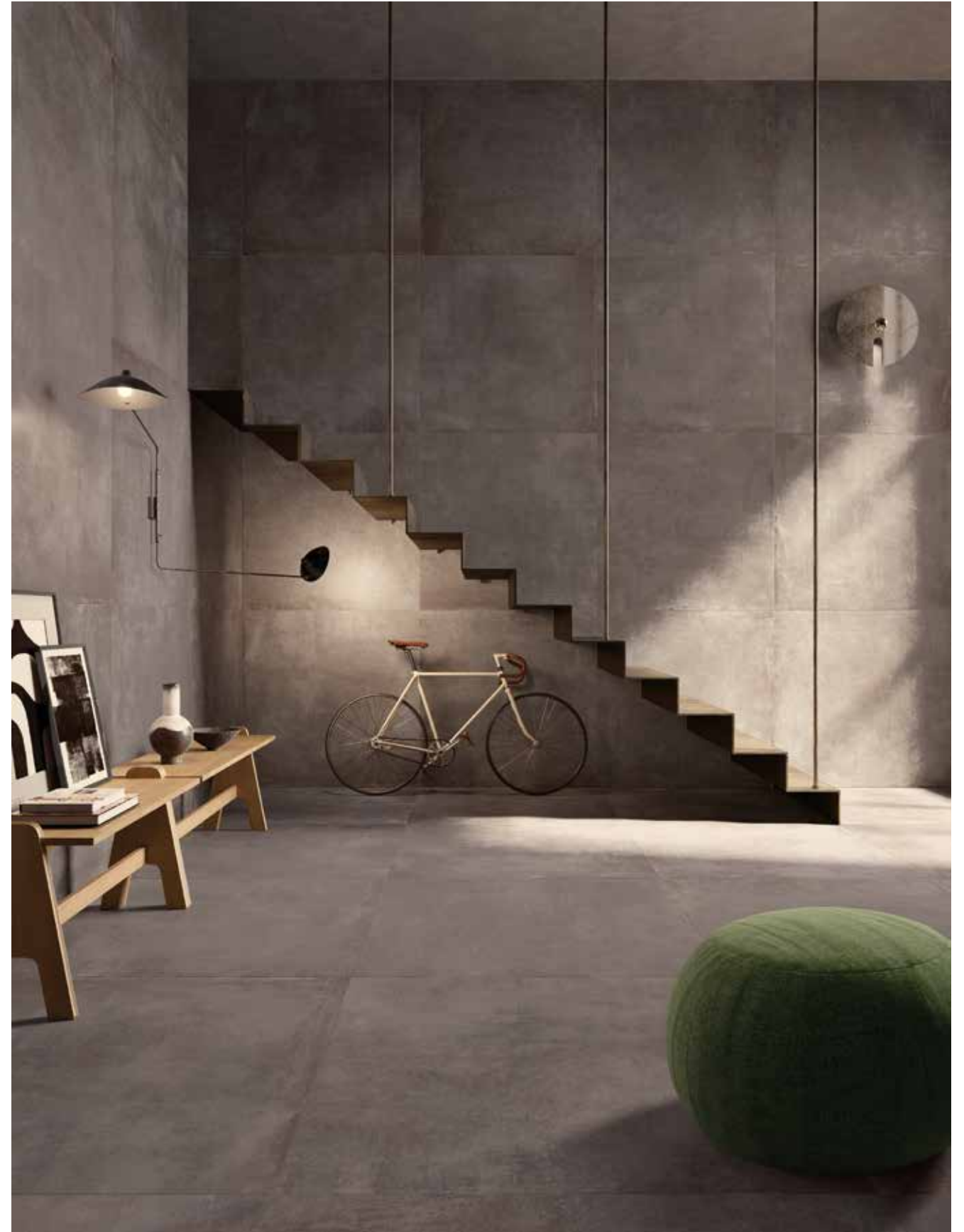

noord taupe



LISTELLO UP 9,7x60 (37/8"x24")

---

120x120 (48"x48")

---

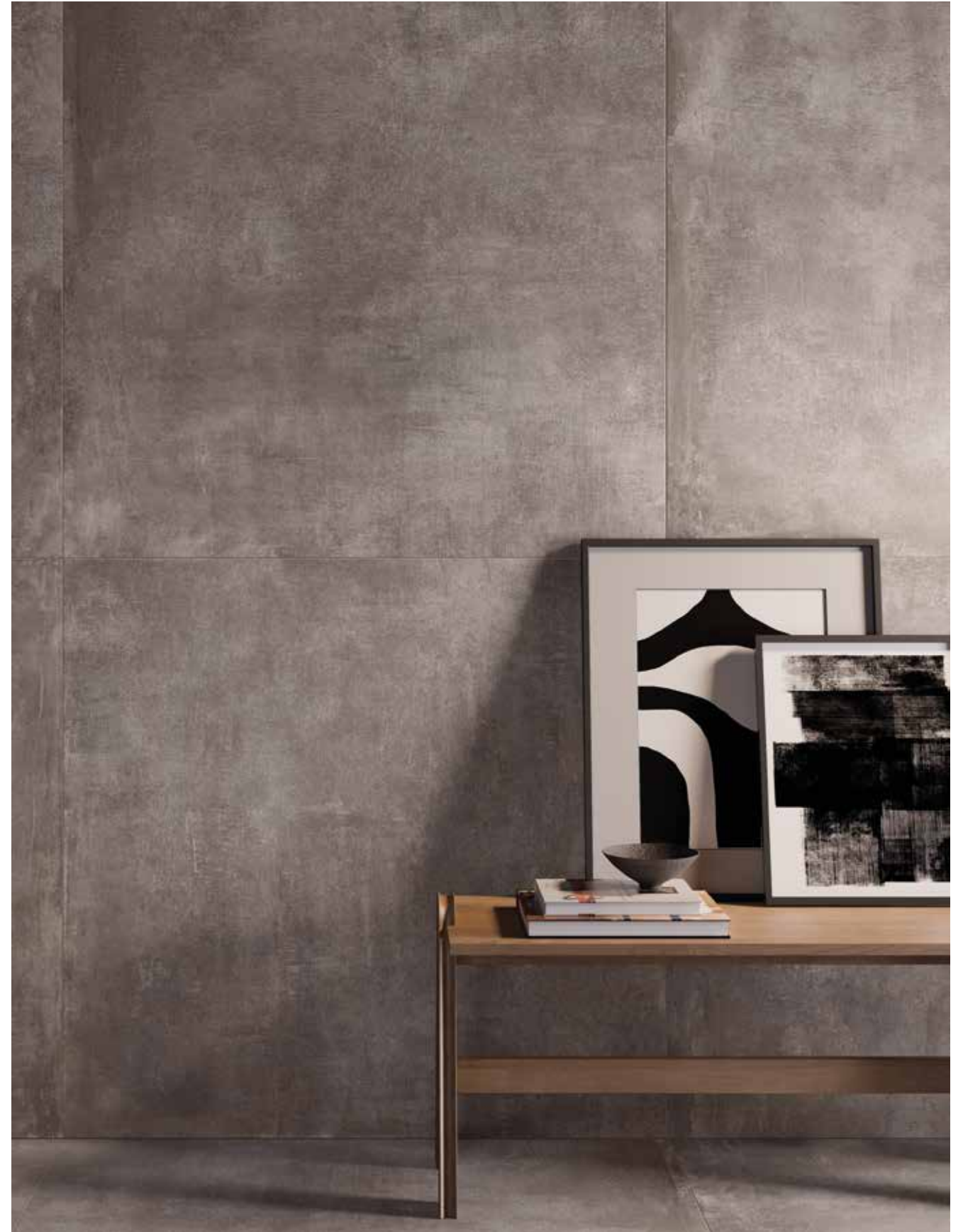

noord taupe

120x120 (48"x48")

---



noord taupe

# gold

120x120 (48"x48")

---



noord gold



60x60 (24"x24") K2 20 mm

noord gold





120x120 (48"x48")

---

DECORO DOCKS 30x60 (12"x24") -  
BACCHETTA MOKA 0,8x30 (25/64"x12")

---



noord gold

# white

60x120 (24"x48") - 80x80 (32"x32")

---



noord white

80x80 (32"x32")

---



noord white



30x120 (12"x48")

120x120 (48"x48") K2 20mm



noord white

# HOME DECOR



**LAVELLO A COLONNA**  
*COLUMN SINK*



DISPONIBILE IN / AVAILABLE IN  
50x50x85 cm

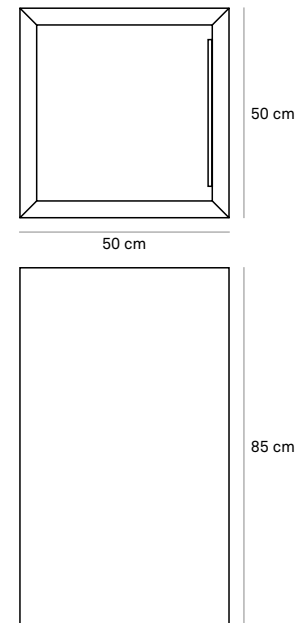

**LAVELLO DA APPOGGIO**  
*COUNTERTOP SINK*



DISPONIBILE IN / AVAILABLE IN  
35x50x8,5 cm

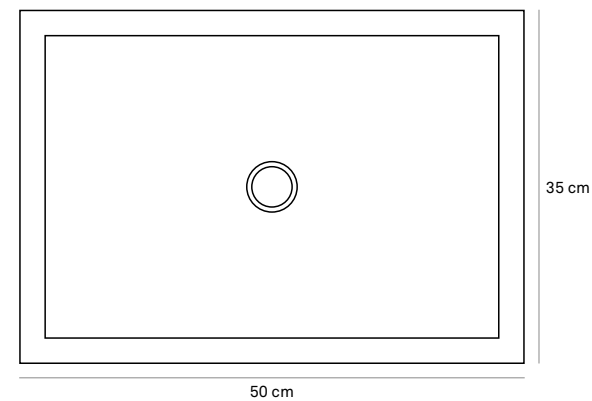

DISPONIBILE IN / AVAILABLE IN  
50x120x9 cm  
50x160x9 cm

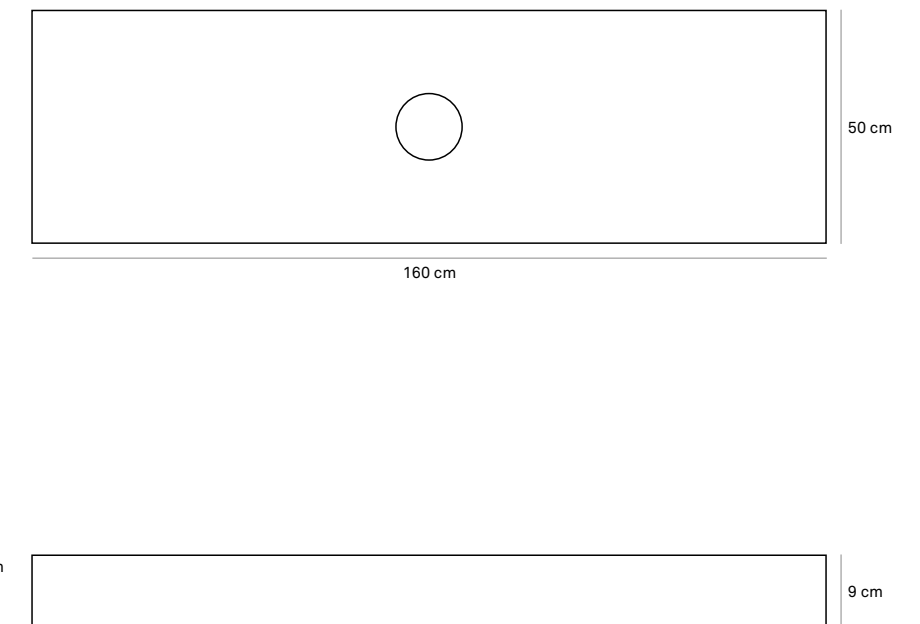

# HOME DECOR



**PIATTO DOCCIA\***  
SHOWER TRAY



DISPONIBILE IN / AVAILABLE IN

80x120 cm  
80x135 cm  
90x135 cm  
90x160 cm

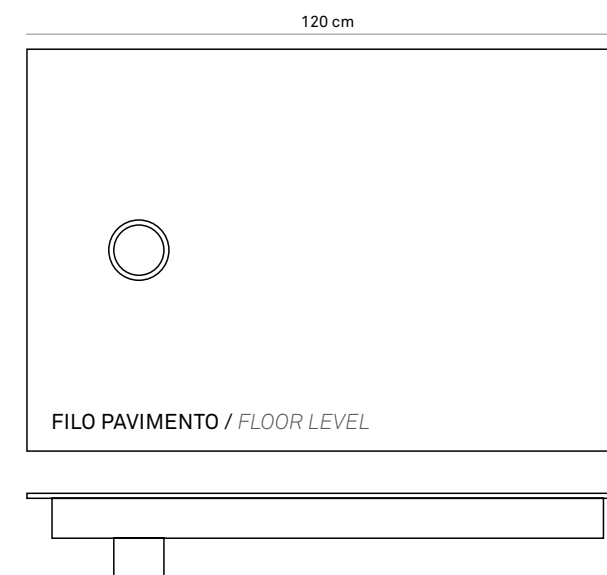

DISPONIBILE IN / AVAILABLE IN

80x120x4 cm  
80x135x4 cm  
90x135x4 cm  
90x160x4 cm

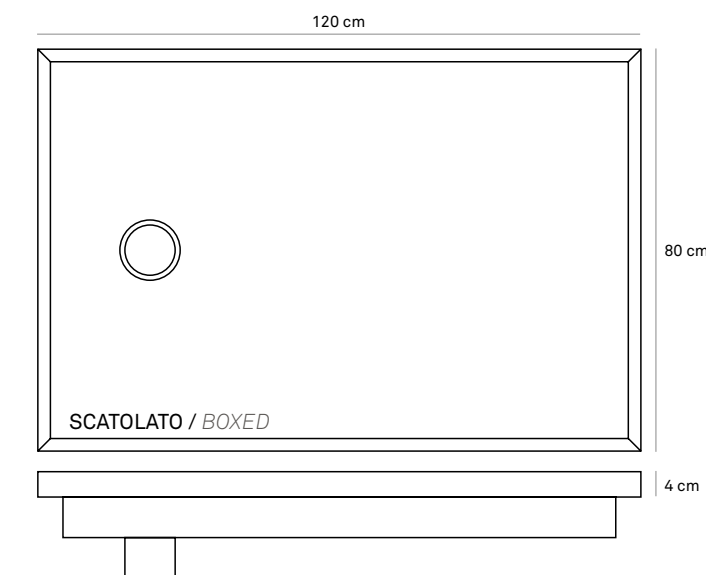

**TAVOLINO CIRCOLARE**  
CIRCULAR TABLE



DISPONIBILE IN / AVAILABLE IN

Ø 42 cm H 50 cm  
Ø 58 cm H 50 cm  
Ø 73 cm H 39 cm

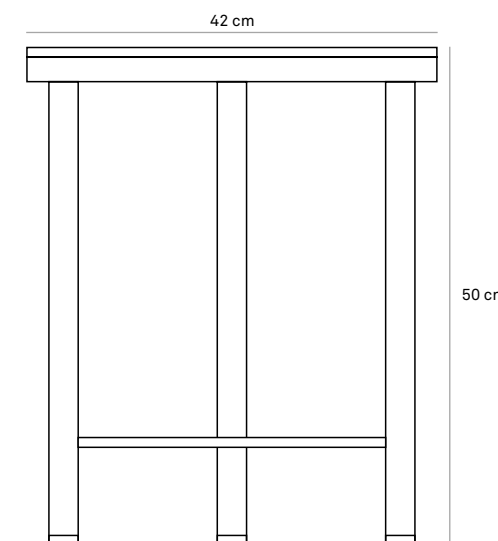

IT\_

**\*Attenzione.** Per ottenere una superficie antiscivolo nel piatto doccia è necessario stendere un tappeto idoneo ad assicurare una presa sicura del piede in presenza di acqua.

EN\_

**\*Warning.** To obtain a non-slip surface in the shower tray it is necessary to lay down a carpet suitable to ensure a secure grip of the foot in the presence of water.

# NOORD

## SPECIFICHE TECNICHE/ TECHNICAL FEATURES

---

**GRES PORCELLANATO TUTTA MASSA UGL**  
*FULL-BODY PORCELAIN UGL*

---

**SPESSORI**  
*THICKNESSES*

**9 mm** (120x120 - 60x120 - 30x120 - 80x80 - 60x60 - 30x60 - 9,7x60)

**20 mm** (120x120 K2 - 60x60 K2 - 30x60 K2)

---

**STONALIZZAZIONE**  
*SHADING*



---

**CLASSIFICAZIONE ANTISDRUCCIOLO**  
*ASSESSMENT OF SLIP RESISTANCE*

**DIN 51130** R10 - R11

**DIN 51097** A+B - A+B+C

**COF** Conforme/*Compliant*

**DCOF** Conforme/*Compliant*

**PENDULUM + 36 PTV 96** 120x120 - 60x120 - 30x120  
- 80x80 - 60x60 - 30x60 - 9,7x60

---

GRES PORCELLANATO /  
PORCELAIN STONEWARE



**INATTACCABILE DA ACIDI /**  
*NOT ATTACKED BY ACIDS*



**RESISTENTE A GELO E SHOCK TERMICI /**  
*RESISTANT TO FROST AND SUDDEN THERMAL CHANGES*



**100% ACQUE REFLUE RECUPERATE /**  
*100% RECOVERED WASTE WATER*



**ENERGIA AUTO-PRODOTTA DA  
FOTOVOLTAICO /**  
*ENERGY SELF-PRODUCED BY PV PLANT*



**FACILMENTE PULIBILE /**  
*EASY TO CLEAN*



**RESISTENTE A SFORZI ED ABRASIONI /**  
*RESISTANT TO STRESSES AND ABRASION*

*500 Kg/cm<sup>2</sup> di pressatura meccanica e cottura a 1.250°C /  
500 kg/cm<sup>2</sup> of mechanical pressing and firing at 1250°C*



**98% RIFIUTI AVVIATI A  
RACCOLTA DIFFERENZIATA /**  
*98% WASTE SENT TO SEPARATE COLLECTION*



**\* + 5.000.000 L = 3.000.000**   
**ACQUE DI PROCESSO DA ALTRI  
STABILIMENTI /**  
*PROCESS WATER FROM OTHER FACTORIES*



**ANTISDRUCCIOLO /**  
*ANTI-SLIP*

*per ambienti bagnati e outdoor /  
for outdoor and wet environments*



**STABILE CROMATICAMENTE /**  
*CHROMATICALLY FAST*

*inalterabile da agenti atmosferici e smog /  
unchanged by weather agents and smog*



**100% PALLET FAO /**  
*100% FAO PALLETS*



**\* 18.408 t = 570**   
**MATERIE PRIME NON ESTRATTE  
GRAZIE AL RECUPERO DI SCARTI /**  
*NON-EXTRACTED RAW MATERIALS THANKS TO THE  
RECOVERY OF SCRAPS*



**NON REAGISCE AL FUOCO /**  
*DOES NOT REACT TO FIRE*

*non emette fumi in caso di incendio /  
does not release fumes in case of fire*



**ASSORBIMENTO H<sub>2</sub>O NULLO /**  
*NULL H<sub>2</sub>O ABSORPTION*



**100% SCARTI CRUDI RECUPERATI /**  
*100% RECOVERED RAW SCRAPS*



**\* + 24.000 MWh/year = 185.000**   
**84% ENERGIA AUTO PRODOTTA DA IMPIANTI  
DI COGENERAZIONE /**  
*84% ENERGY SELF-PRODUCED BY COGENERATION PLANTS*



ANTHRACITE



GREY



TAUPE



GOLD



WHITE



**V2**  
STONALIZZAZIONE/  
SHADING

ANTHRACITE **V2**



GREY **V2**



specs & tech

TAUPE **V2**

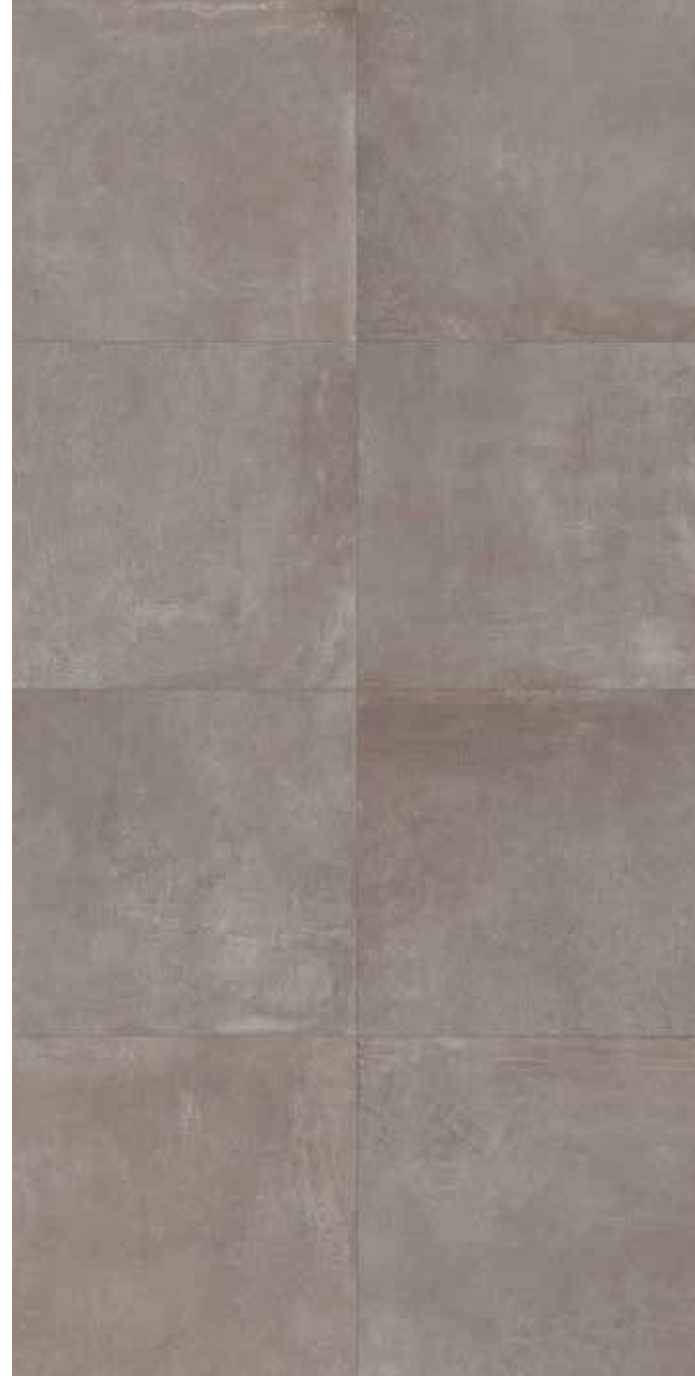

GOLD **V2**



WHITE **V2**



# 10 FORMATI/ SIZES



● 120x120 (48"x48") RT 9 mm  
▲ 120x120 (48"x48") RT **K2** 20 mm

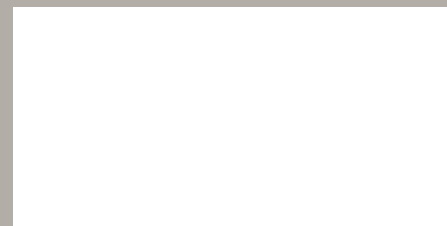

● 60x120 (24"x48") RT 9 mm



● 30x120 (12"x48") RT 9 mm



● 80x80 (32"x32") RT 9 mm

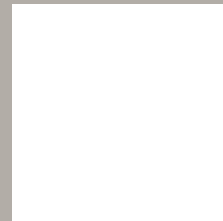

● 60x60 (24"x24") RT 9 mm  
▲ 60x60 (24"x24") RT **K2** 20 mm



● 30x60 (12"x24") RT 9 mm  
▲ 30x60 (12"x24") RT **K2** 20 mm



● 9,7x60 (3<sup>7/8</sup>"x24") RT 9 mm

● Natural R10 | ▲ Grip R11

# 3 DECORI/ DECORS

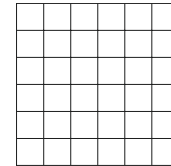

MOSAICO ● 30x30 (12"x12") RT 9 mm  
(TESSERE: 4,8x4,8 - 1<sup>7/8</sup>"x1<sup>7/8</sup>")

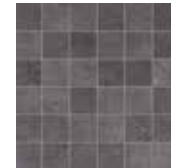

NOORD ANTHRACITE



NOORD GREY



NOORD TAUPE



NOORD GOLD



NOORD WHITE



LISTELLO UP ● 9,7x60 (3<sup>7/8</sup>"x24") RT 9 mm



NOORD ANTHRACITE



NOORD GREY

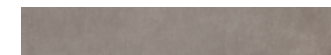

NOORD TAUPE



NOORD GOLD



NOORD WHITE

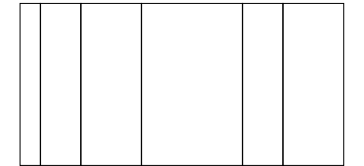

DECORO DOCKS ● 30x60 (12"x24") RT 9 mm



NOORD ANTHRACITE



NOORD GREY



NOORD TAUPE



NOORD GOLD



NOORD WHITE

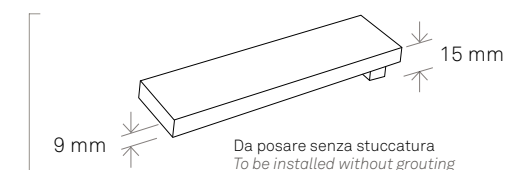

# 7

## PEZZI SPECIALI/ TRIMS

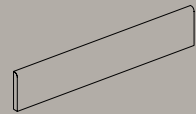

### BATTISCOPA

- 4,6x120 (1<sup>13</sup>/<sub>16</sub>"x48") RT 9 mm
- 7x80 (2<sup>3</sup>/<sub>4</sub>"x32") RT 9 mm
- 7,2x60 (2,8"x24") RT 9 mm

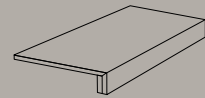

### SCALINO INCOLLATO

- 33x60 (13"x24") RT 9 mm



### ANGOLARE INCOLLATO

- 33x33 (13"x13") RT 9 mm

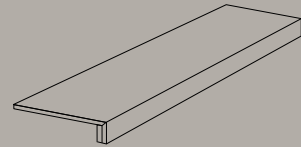

### SCALINO INCOLLATO

- 33x120 (13"x48") RT 9 mm

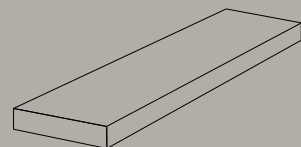

### ANGOLARE INCOLLATO

- 33x120 (13"x48") RT 9 mm

# 17

## PEZZI SPECIALI K<sub>2</sub>/ TRIMS K<sub>2</sub>

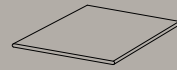

### ANGOLARE BORDO CON TORO

- ▲ 30x30 (12"x12") RT 20 mm

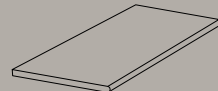

### GRADINO BORDO CON TORO

- ▲ 60x120 (24"x48") RT 20 mm
- ▲ 30x120 (12"x48") RT 20 mm
- ▲ 30x60 (12"x24") RT 20 mm

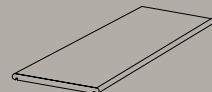

### TOP

- ▲ 30x60 (12"x24") RT 20 mm

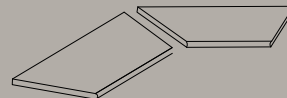

### GRADINO ANGOLO INTERNO BORDO CON TORO

- ▲ 60x120 (24"x48") RT 20 mm
- ▲ 30x120 (12"x48") RT 20 mm
- ▲ 30x60 (12"x24") RT 20 mm

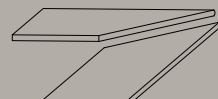

### GRADINO ANGOLO ESTERNO BORDO CON TORO

- ▲ 60x120 (24"x48") RT 20 mm
- ▲ 30x120 (12"x48") RT 20 mm
- ▲ 30x60 (12"x24") RT 20 mm

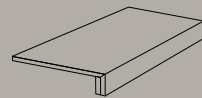

### TERMINALE "L"

- ▲ 120x45x15 (48"x18"x6") RT 20 mm
- ▲ 60x33x5 (24"x13"x2") RT 20 mm
- ▲ 60x20x5 (24"x8"x2") RT 20 mm

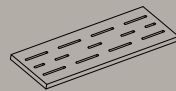

### GRIGLIA

- ▲ 15x60 (6"x24") RT 20 mm

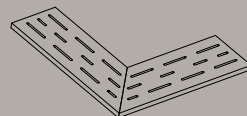

### ANGOLARE GRIGLIA

- ▲ 15x60 (6"x24") RT 20 mm

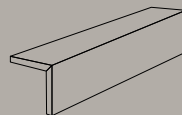

### CORDOLO "L"

- ▲ 60x20x15 (24"x8"x6") RT 20 mm

## SCHEMI DI POSA/ LAYING SYSTEM

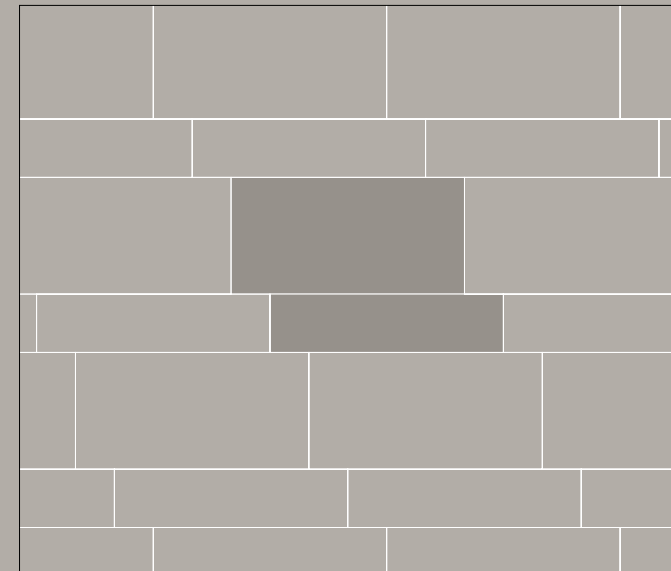

- 30x120 (12"x48") RT - 33,33%
- 60x120 (24"x48") RT - 66,66%

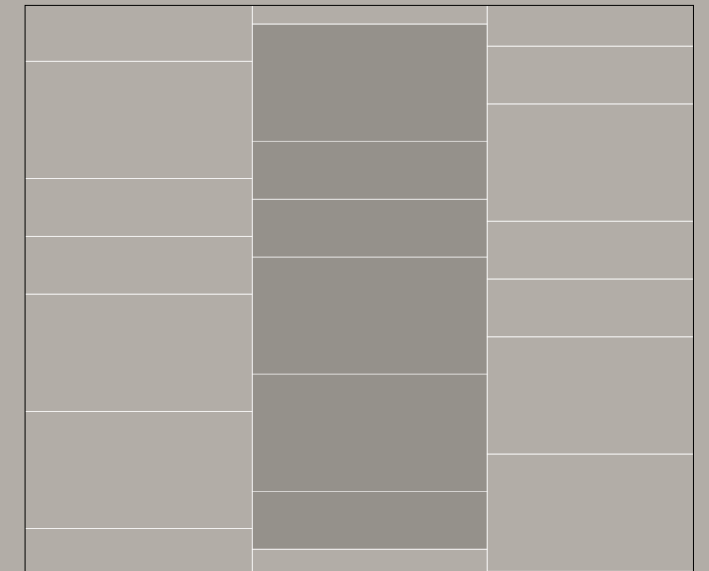

- 30x120 (12"x48") RT - 33,33%
- 60x120 (24"x48") RT - 66,66%

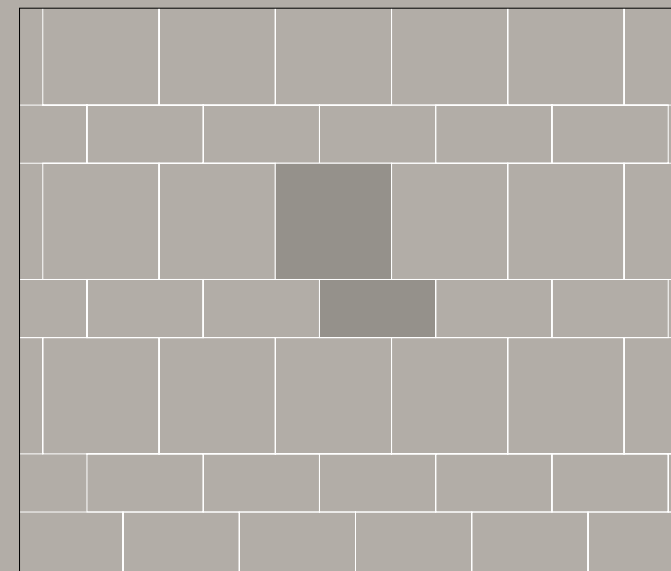

- 30x60 (12"x24") RT - 33,33%
- 60x60 (24"x24") RT - 66,66%

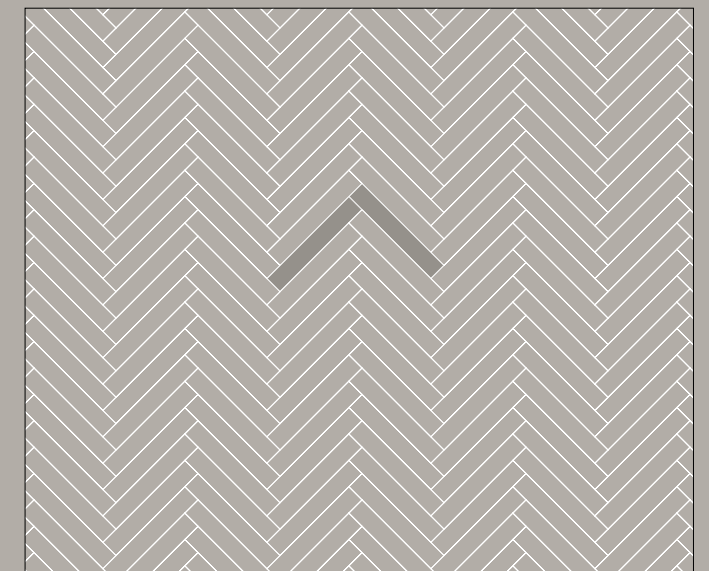

- 9,7x60 (3<sup>7</sup>/<sub>8</sub>"x24") RT - 100,00%

Fuga minima consigliata per posa in interno 2 mm, in esterno 4 mm  
 Minimum suggested joint for indoor laying 2 mm, for outdoor 4 mm  
 Consigli di posa, pulizia e manutenzione al link [keope.com](http://keope.com)  
 Consigli di posa, pulizia e manutenzione al link [keope.com](http://keope.com)

## New

### **Natural R10 / A+B**

La tecnologia Natural R10 porta il grado di finitura a un nuovo livello: all'alto coefficiente di attrito si aggiunge la morbidezza e praticità della superficie liscia. Proprietà fondamentali come la capacità antiscivolo, la resistenza all'usura e agli agenti atmosferici si combinano a caratteristiche estetiche tipiche dell'interior design più sofisticato. Con questa doppia anima, la finitura regala una spinta progettuale inedita ai pavimenti in gres porcellanato, assicurando performance antiscivolo e semplicità di gestione della superficie: oggi, più che mai, in perfetta sintonia e corrispondenza con le esigenze per gli spazi coperti di ogni genere.

### **Natural R10 / A+B**

*It's the technology behind the Natural R10 range that brings the quality of the finish to a whole new level: silky and smooth but also anti-slip, due to a higher coefficient of friction in the surface finish, also resistant to decay and damage from the atmosphere. These fundamental properties - both material and aesthetic give the tile a 'double soul' - where today's most forward-thinking interior design styles are underwritten with total performance. Easy to maintain, effortless to use in design, Natural R10 demonstrates how today, more than ever, our finishes are in tune with the whole range of demands placed on them in any space.*

Grip R11

Natural R10

FORMATI / SIZES

	120x120 (119,5x119,5)* 48"x48"	60x120 24"x48"	30x120 12"x48"	80x80 32"x32"	60x60 24"x24"	30x60 12"x24"	9,7x60 3 7/8"x24"	120x120 (119,5x119,5)* 48"x48"	60x60 24"x24"	30x60 12"x24"
working size	1194x1194	596x1195	297x1195	797x797	596x596	297x596	97x596	1194x1194	596x596	297x596
	RT	RT	RT	RT	RT	RT	RT	RT	RT	RT
	9 mm	9 mm	9 mm	9 mm	9 mm	9 mm	9 mm	K2 20 mm	K2 20 mm	K2 20 mm
NOORD ANTHRACITE	●	●	●	●	●	●	●		▲	▲
NOORD GREY	●	●	●	●	●	●	●	▲	▲	▲
NOORD TAUPE	●	●	●	●	●	●	●			
NOORD GOLD	●	●	●	●	●	●	●		▲	▲
NOORD WHITE	●	●	●	●	●	●	●	▲	▲	▲









\*Formato nominale / Nominal size

● Natural R10 | ▲ Grip R11

MISURE, PESI ED IMBALLI / SIZE, WEIGHT AND PACKAGING

FORMATO SIZE	SPESSORE THICKNESS	PZ/SCATOLA PIECES/BOX	MQ/SCATOLA SQM/BOX	KG/SCATOLA KG/BOX	MQ/PALLET SQM/PALLET	KG/PALLET KG/PALLET	SCATOLA/PALLET BOX/PALLET
120x120	9 mm	2	2,86	60,80	57,12	1.229,00	20
60x120	9 mm	2	1,44	33,40	50,40	1.182,00	35
30x120	9 mm	4	1,44	31,48	51,84	1.146,28	36
80x80	9 mm	2	1,28	25,60	53,76	1.088,20	42
60x60	9 mm	3	1,08	20,83	43,20	846,20	40
30x60	9 mm	7	1,26	25,00	50,40	1.013,00	40
9,7x60	9 mm	10	0,58	13,00	34,92	793,00	60
120x120 K2	20 mm	1	1,43	67,10	28,56	1.355,00	20
60x60 K2	20 mm	2	0,72	34,00	21,60	1.033,00	30
30x60 K2	20 mm	3	0,54	24,67	21,60	999,80	40

INFORMAZIONI TECNICHE / TECHNICAL FEATURES

INFORMAZIONI TECNICHE TECHNICAL FEATURES	NORMA NORM EN 14411 - ISO 13006	REQUISITI PRESCRITTI REQUIRED VALUES	VALORI VALUES
 <b>DIMENSIONI RETTIFICATO</b> SIZES RECTIFIED	UNI EN ISO 10545-2	lunghezza-larghezza / length-width ±0,3% (±1,0 mm max) spessore / thickness ±5,0% (±0,5 mm max) ortogonalità / rectangularity ±0,3% (±1,5 mm max) rettilinearità / straightness ±0,3% (±0,8 mm max) planarità / flatness ±0,4% (±1,8 mm max) qualità superficie / surface quality ≥95%	<b>CONFORME</b> COMPLIANT
 <b>ASSORBIMENTO ACQUA</b> WATER ABSORPTION	UNI EN ISO 10545-3	≤0,5%	≤0,1%
 <b>RESISTENZA A ROTTURA</b> BREAKING STRENGTH	UNI EN ISO 10545-4	R≥35 N/mm <sup>2</sup> S≥700 N (<7,5 mm) S≥1300 N (≥7,5 mm)	<b>9 mm</b> <b>CONFORME</b> COMPLIANT <b>20 mm</b> R≥45 N/mm <sup>2</sup> S≥10000 N
 <b>RESISTENZA ABRASIONE PROFONDA (UGL - Matt)</b> DEEP ABRASION RESISTANCE (UGL - Matt)	UNI EN ISO 10545-6	≤175 mm <sup>3</sup>	≤150 mm <sup>3</sup>
 <b>RESISTENZA SHOCK TERMICI</b> THERMAL SHOCK RESISTANCE	UNI EN ISO 10545-9	resistenza / resistant	<b>CONFORME</b> COMPLIANT
 <b>RESISTENZA AL GELO</b> FROST RESISTANCE	UNI EN ISO 10545-12	resistenza / resistant	<b>CONFORME</b> COMPLIANT
 <b>RESISTENZA CHIMICA</b> CHEMICAL RESISTANCE	UNI EN ISO 10545-13	resistenza / resistant	<b>CONFORME</b> COMPLIANT
 <b>RESISTENZA ALLE MACCHIE</b> RESISTANCE TO STAINS	UNI EN ISO 10545-14	pulibile / cleanable	<b>CONFORME</b> COMPLIANT
	DIN 51130	R	prodotto / product R A+B+C >0,40 >0,42
	DIN 51097	A+B+C	120x120 - 60x120 - 30x120 - 80x80 - 60x60 - 30x60 - 9,7x60 R10 A+B <b>CONFORME</b> COMPLIANT
 <b>CLASSIFICAZIONE ALTISDRUCCIOLO</b> ASSESSMENT OF SLIP RESISTANCE	B.C.R.A. (COF) ANSI A137.1 2012 (DCOF) Pendulum Test Value PTV 96 (R10)	>0,40 bagnato / wet >0,42 bagnato / wet > 36	120x120 K2 - 60x60 K2 - 30x60 K2 R11 A+B+C <b>CONFORME</b> COMPLIANT 120x120 - 60x120 - 30x120 - 80x80 - 60x60 - 30x60 - 9,7x60

Piastrelle pressate a secco - Conforme alla norma EN 14411 e ISO 13006 appendice G gruppo B1-a con E ≤0,5%  
Dry pressed tiles - Compliant with standards EN 14411 and ISO 13006 annex G group B1-a with E ≤0,5%



---

**HEADQUARTER** via statale 467, 21  
42013 Casalgrande (RE) - Italy  
**FACTORY** via canale, 67  
42013 Casalgrande (RE) - Italy  
**WAREHOUSE** via dell'industria, 1  
42013 Casalgrande (RE) - Italy

---

**PHONE** +39 0522 997511  
**FAX** +39 0522 997544 (OT) - 545 (IT)  
**ADMIN. FAX** +39 0522 997413

---

[info@keope.com](mailto:info@keope.com)  
[keope.com](http://keope.com)

**IT\_**  
Ceramiche Keope si riserva la facoltà di apportare variazioni ai prodotti illustrati in questo catalogo per necessità produttive o al fine di migliorarne la qualità. I campioni sono puramente indicativi. Gli imballaggi e pesi riportati possono variare per necessità produttive. Consultare gli uffici commerciali al momento dell'ordine.

**EN\_**  
*Ceramiche Keope reserves the right to vary the products illustrated in this catalogue for production purposes or in order to improve quality. Samples are purely indicative. Packaging and weights shown may be varied in line with production requirements. Check with the sales department at the time of order.*



