



URBAN

#CONCRETE

 porcelaingres®
de_tiles



#CONCRETE

URBAN

We live surrounded by ideas. The precision of architecture, which lets us change the horizon and make it our own; the power of design, capable of creating a space starting from a unique perspective. The cement of the sure, unchanging foundations beneath our feet, on which the city rests, and our lives unfold. It's from the streets, from these glass and iron horizons, from the character of cement and dynamism of city life that Urban is born, the new collection from Porcelaingres.

Wir leben in einer Welt voller Ideen. Die Präzision der Architektur, mit der wir unseren Horizont ändern und unseren Bedürfnissen anpassen: Die Stärke des Designs, das in der Lage ist, aus einem einzigen Gesichtspunkt einen Raum zu bilden. Der Zement der sicheren und unveränderlichen Fundamente zu unseren Füßen, auf denen unsere Stadt aufgebaut ist und auf dem wir unser Leben leben. Auf diesen Straßen, mit diesen Horizonten aus Glas und Eisen, mit den verlässlichen Eigenschaften des Zements und der Dynamik des städtischen Lebens entsteht Urban, die neue Kollektion von Porcelaingres.

Nous vivons entourés par des idées. La précision de l'architecture, qui nous permet de modifier l'horizon et de nous l'approprier... La puissance du design, capable de créer un espace en partant d'un seul point de vue... Le ciment des fondations sûres et immuables sous nos pieds sur lesquelles s'appuie la ville et se déroulent nos vies... Ce sont ces routes, ces horizons de verre et d'acier, le caractère du ciment et le dynamisme de la vie en ville qui donnent naissance à Urban, la nouvelle collection Porcelaingres.

Viviamo circondati da idee. La precisione dell'architettura, che ci permette di cambiare l'orizzonte e di farlo nostro; la potenza del design, capace di creare uno spazio partendo da un solo punto di vista. Il cemento delle fondamenta certe e immutabili sotto ai nostri piedi sulle quali si appoggia la città, e si svolgono le nostre vite. È da queste strade, da questi orizzonti di vetro e di ferro, dal carattere del cemento e dal dinamismo della vita di città che nasce Urban, la nuova collezione Porcelaingres.

Vivimos rodeados de ideas. La precisión de la arquitectura, que nos permite cambiar la perspectiva y aceptarla; el poder del diseño, capaz de crear un espacio partiendo desde un solo punto de vista. El hormigón de los cimientos seguros e inmutables bajo nuestros pies, sobre los que se apoya la ciudad y se desarrollan nuestras vidas. Es de estas calles, de estas perspectivas de vidrio y hierro, del carácter del cemento y del dinamismo de la vida urbana que surge Urban, la nueva serie de Porcelaingres.







urban dove



urban grey
urban weave grey



urban grey
urban ivory



#CONCRETE

URBAN ANTHRACITE



natural | natur | naturale | naturel | natural **R10 A+B UGL**

* natural | natur | naturale | naturel | natural **R11 A+B UGL**

natural | natur | naturale | naturel | natural **R10 A+B UGL**

natural | natur | naturale | naturel | natural **R11 A+B UGL**

✂ 6 mm

✂ 8 mm

✂ 8 mm

✂ 20 mm



👁 #GREAT

Also available in 300x100, 150x100 and 100x100 sizes. More info in the #GREAT catalogue.
 Verfügbar im Format 300x100, 150x100 und 100x100. Weitere Informationen finden Sie in unserm Katalog #GREAT.
 Disponibile in formato 300x100, 150x100 e 100x100. Maggiori informazioni nel catalogo #GREAT.
 Disponible en formats 300x100, 150x100 et 100x100. Plus d'informations dans le catalogue #GREAT.
 Disponible en formato de 300x100, 150x100 y 100x100. Más información en el #GREAT catálogo.

SIZE
FORMAT
FORMATO
FORMAT
FORMATOS

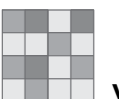
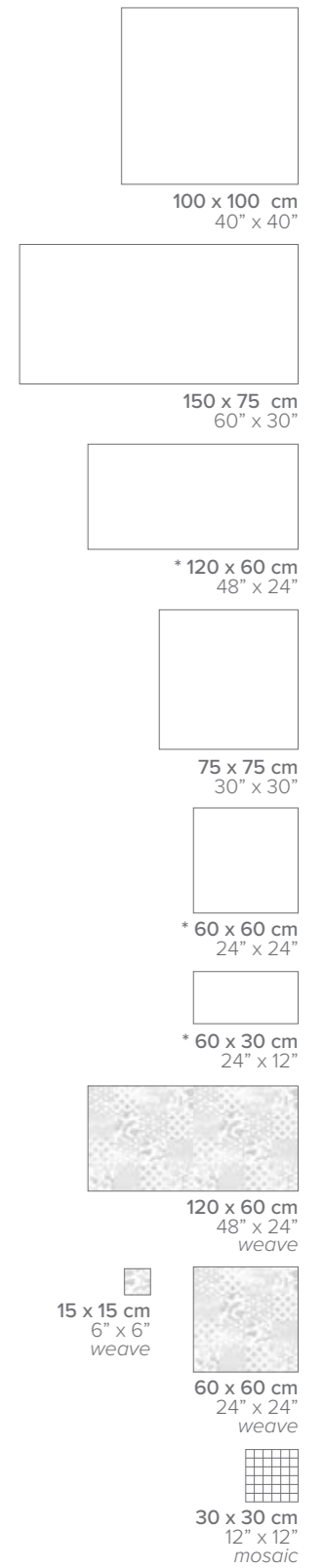

V3

#CONCRETE

URBAN DOVE



natural | natur | naturale | naturel | natural **R10 A+B UGL**
 * natural | natur | naturale | naturel | natural **R11 A+B UGL**
 natural | natur | naturale | naturel | natural **R10 A+B UGL**
 natural | natur | naturale | naturel | natural **R11 A+B UGL**

✂ 6 mm
 ✂ 8 mm
 ✂ 8 mm
 ✂ 20 mm

SIZE
 FORMAT
 FORMATO
 FORMAT
 FORMATOS



👁 #GREAT

Also available in 300x100, 150x100 and 100x100 sizes. More info in the #GREAT catalogue.
 Verfügbar im Format 300x100, 150x100 und 100x100. Weitere Informationen finden Sie in unserm Katalog #GREAT.
 Disponibile in formato 300x100, 150x100 e 100x100. Maggiori informazioni nel catalogo #GREAT.
 Disponible en formats 300x100, 150x100 et 100x100. Plus d'informations dans le catalogue #GREAT.
 Disponible en formato de 300x100, 150x100 y 100x100. Más información en el #GREAT catálogo.

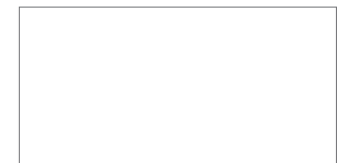

150 x 75 cm
 60" x 30"

6 mm

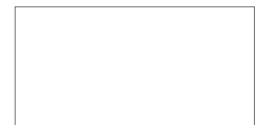

* 120 x 60 cm
 48" x 24"

8 mm - 20 mm

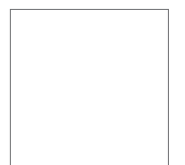

75 x 75 cm
 30" x 30"

6 mm



* 60 x 60 cm
 24" x 24"

8 mm - 20 mm

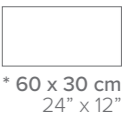

* 60 x 30 cm
 24" x 12"

8 mm



120 x 60 cm
 48" x 24"
 weave

8 mm



60 x 60 cm
 24" x 24"
 weave

8 mm



15 x 15 cm
 6" x 6"
 weave

8 mm



30 x 30 cm
 12" x 12"
 mosaic

8 mm

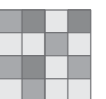

V3

#CONCRETE

URBAN GREY



natural | natur | naturale | naturel | natural **R10 A+B UGL**
 * natural | natur | naturale | naturel | natural **R11 A+B UGL**
 natural | natur | naturale | naturel | natural **R10 A+B UGL**
 natural | natur | naturale | naturel | natural **R11 A+B UGL**

✂ 6 mm
 ✂ 8 mm
 ✂ 8 mm
 ✂ 20 mm

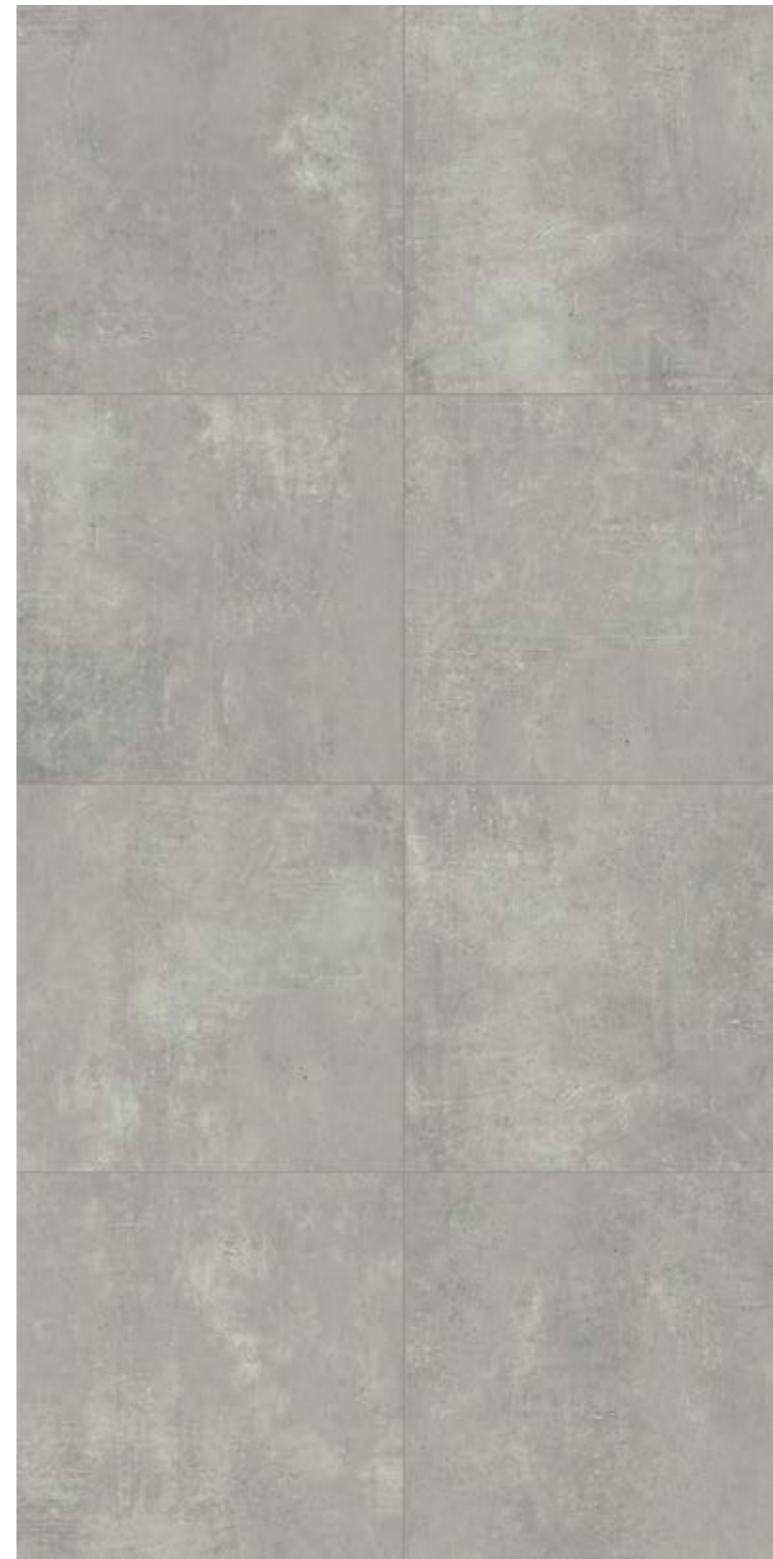

👁 #GREAT

Also available in 300x100, 150x100 and 100x100 sizes. More info in the #GREAT catalogue.
 Verfügbar im Format 300x100, 150x100 und 100x100. Weitere Informationen finden Sie in unserm Katalog #GREAT.
 Disponibile in formato 300x100, 150x100 e 100x100. Maggiori informazioni nel catalogo #GREAT.
 Disponible en formats 300x100, 150x100 et 100x100. Plus d'informations dans le catalogue #GREAT.
 Disponible en formato de 300x100, 150x100 y 100x100. Más información en el #GREAT catálogo.

SIZE
 FORMAT
 FORMATO
 FORMAT
 FORMATOS

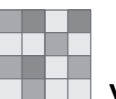
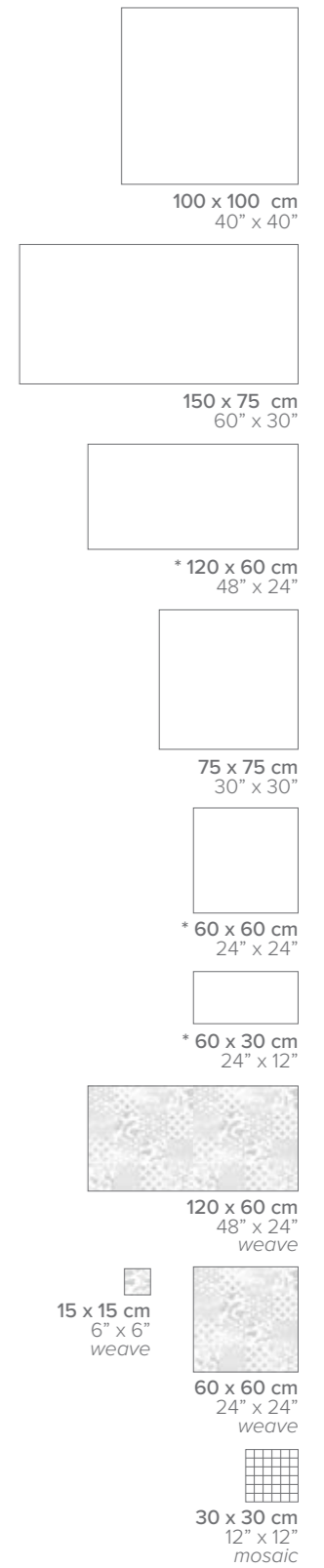

V3

#CONCRETE

URBAN SAND



natural | natur | naturale | naturel | natural **R10 A+B UGL**

* natural | natur | naturale | naturel | natural **R11 A+B UGL**

natural | natur | naturale | naturel | natural **R10 A+B UGL**

natural | natur | naturale | naturel | natural **R11 A+B UGL**

✂ 6 mm

✂ 8 mm

✂ 8 mm

✂ 20 mm

SIZE
FORMAT
FORMATO
FORMAT
FORMATOS



👁 #GREAT

Also available in 300x100, 150x100 and 100x100 sizes. More info in the #GREAT catalogue.
Verfügbar im Format 300x100, 150x100 und 100x100. Weitere Informationen finden Sie in unserm Katalog #GREAT.
Disponibile in formato 300x100, 150x100 e 100x100. Maggiori informazioni nel catalogo #GREAT.
Disponible en formats 300x100, 150x100 et 100x100. Plus d'informations dans le catalogue #GREAT.
Disponible en formato de 300x100, 150x100 y 100x100. Más información en el #GREAT catálogo.

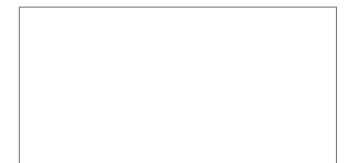

150 x 75 cm
60" x 30"

6 mm

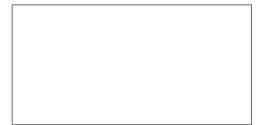

* 120 x 60 cm
48" x 24"

8 mm - 20 mm



75 x 75 cm
30" x 30"

6 mm



* 60 x 60 cm
24" x 24"

8 mm - 20 mm

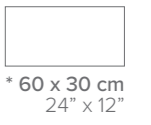

* 60 x 30 cm
24" x 12"

8 mm



120 x 60 cm
48" x 24"
weave

8 mm



60 x 60 cm
24" x 24"
weave

8 mm



15 x 15 cm
6" x 6"
weave

8 mm



30 x 30 cm
12" x 12"
mosaic

8 mm

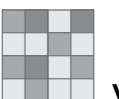

V3

#CONCRETE

URBAN IVORY



natural | natur | naturale | naturel | natural **R10 A+B UGL**

* natural | natur | naturale | naturel | natural **R11 A+B UGL**

natural | natur | naturale | naturel | natural **R10 A+B UGL**

natural | natur | naturale | naturel | natural **R11 A+B UGL**

✂ 6 mm

✂ 8 mm

✂ 8 mm

✂ 20 mm



👁 #GREAT

Also available in 300x100, 150x100 and 100x100 sizes. More info in the #GREAT catalogue.
 Verfügbar im Format 300x100, 150x100 und 100x100. Weitere Informationen finden Sie in unserm Katalog #GREAT.
 Disponibile in formato 300x100, 150x100 e 100x100. Maggiori informazioni nel catalogo #GREAT.
 Disponible en formats 300x100, 150x100 et 100x100. Plus d'informations dans le catalogue #GREAT.
 Disponible en formato de 300x100, 150x100 y 100x100. Más información en el #GREAT catálogo.

SIZE
FORMAT
FORMATO
FORMAT
FORMATOS

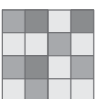
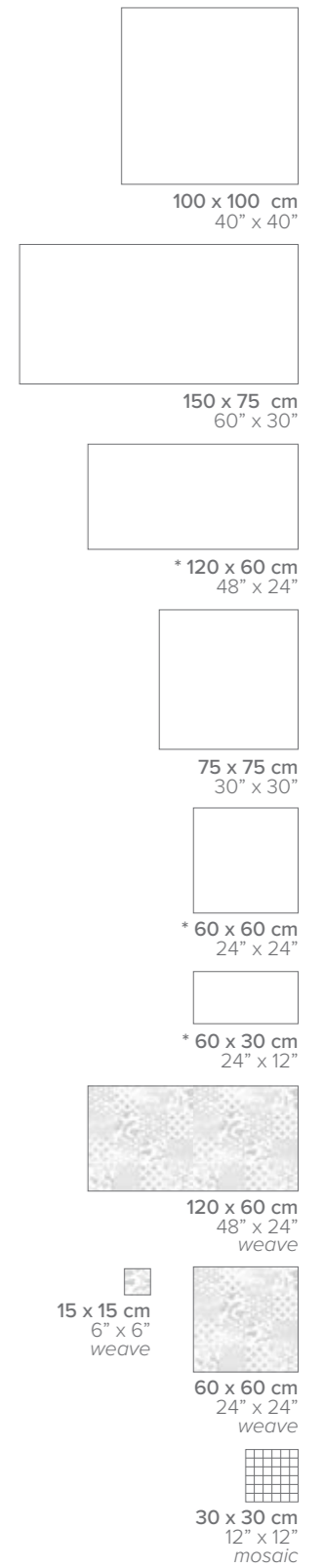

V3

#CONCRETE

URBAN WHITE



natural | natur | naturale | naturel | natural **R10 A+B UGL**

✂ 6 mm

* natural | natur | naturale | naturel | natural **R11 A+B UGL**

✂ 8 mm

natural | natur | naturale | naturel | natural **R10 A+B UGL**

✂ 8 mm

natural | natur | naturale | naturel | natural **R11 A+B UGL**

✂ 20 mm

SIZE
FORMAT
FORMATO
FORMAT
FORMATOS

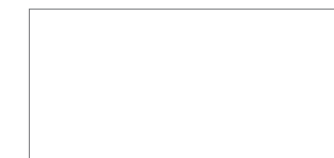

150 x 75 cm
60" x 30"

6 mm



* 120 x 60 cm
48" x 24"

8 mm - 20 mm

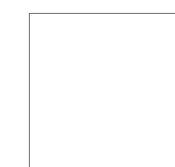

75 x 75 cm
30" x 30"

6 mm



* 60 x 60 cm
24" x 24"

8 mm - 20 mm



* 60 x 30 cm
24" x 12"

8 mm



120 x 60 cm
48" x 24"
weave

8 mm



60 x 60 cm
24" x 24"
weave

8 mm



15 x 15 cm
6" x 6"
weave

8 mm



30 x 30 cm
12" x 12"
mosaic

8 mm

👁 #GREAT

Also available in 300x100, 150x100 and 100x100 sizes. More info in the #GREAT catalogue.
Verfügbar im Format 300x100, 150x100 und 100x100. Weitere Informationen finden Sie in unserm Katalog #GREAT.
Disponibile in formato 300x100, 150x100 e 100x100. Maggiori informazioni nel catalogo #GREAT.
Disponible en formats 300x100, 150x100 et 100x100. Plus d'informations dans le catalogue #GREAT.
Disponible en formato de 300x100, 150x100 y 100x100. Más información en el #GREAT catálogo.

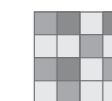

V3

16 designs, endless possibilities.

16 Grafiken, unendlich viele Lösungen.

16 grafiche, infinite soluzioni.

16 graphiques, des solutions infinies.

16 gráficos, infinitas soluciones.



different tone V3
unregelmäßig im Farbton
mosso nel tono
ton nuancé
tonalidad variable

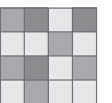

It is not possible to know which particular combination of variations each box will contain.
Die Kombination der Oberflächen im Inneren der einzelnen Kartons ist nicht vorhersehbar.
Non è possibile prevedere la combinazione delle facce all'interno delle singole scatole.
Il est impossible de prévoir la combinaison des faces à l'intérieur de chaque boîte.
No se puede prever la combinación de caras en el interior de cajas individuales.



TECHNICAL FEATURES

Technische Eigenschaften.

Caratteristiche Tecniche.

Caractéristiques Techniques.

Características Técnicas.

NOTE

Porcelaingres reserves the right to modify technical and formal details included in this catalogue.











Porcelaingres behält sich ausdrücklich das Recht vor, technische Änderung vorzunehmen.

Porcelaingres si riserva il diritto di apportare, qualora lo ritenesse opportuno, eventuali modifiche tecniche e formali ai dati riportati in questo catalogo.

Porcelaingres se réserve le droit d'apporter, si nécessaire, des modifications techniques et formelles aux informations présentes en ce catalogue.

Porcelaingres se reserva el derecho de efectuar, en el caso que sea oportuno, eventuales modificaciones técnicas y/o formales a los datos que aparecen en este catalogo.

- production upon request
- Herstellung auf Anfrage
- produzione su richiesta
- production sur demande
- producción bajo demanda

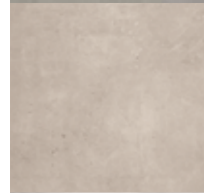
URBAN squared rektifiziert rettificato rectifié rectificados 6 mm R10 A+B UGL 8 mm R10 A+B UGL 20 mm R11 A+B UGL natural natur naturale naturel natural											
	60 x 60 x 0,8 cm Weave	15 x 15 x 0,8 cm Weave	30 x 30 x 0,8 cm mosaic 3,1x3,1 Mosaik 3,1x3,1 mosaico 3,1x3,1 mosaïque 3,1x3,1	30 x 30 x 0,8 cm mosaic 4,7x4,7 Mosaik 4,7x4,7 mosaico 4,7x4,7 mosaïque 4,7x4,7	75 x 9 x 0,6 cm bull nose Sockel battiscopa becco civetta plinthe à bord arrondi zócalo con borde redondeado	60 x 7 x 0,8 cm bull nose Sockel battiscopa becco civetta plinthe à bord arrondi zócalo con borde redondeado	150 x 37,5 x 0,6 cm step with grooves Stufe mit Rillen gradino con scanalature nez de marche paso con ranuras	75 x 37,5 x 0,6 cm step with grooves Stufe mit Rillen gradino con scanalature nez de marche paso con ranuras	120 x 30 x 0,8 cm step with grooves Stufe mit Rillen gradino con scanalature nez de marche paso con ranuras	60 x 30 x 0,8 cm step with grooves Stufe mit Rillen gradino con scanalature nez de marche paso con ranuras	
	urban anthracite	X606290X8	X1556290X8	X373290X8	X370290X8	X975X6290	X670290X8	X3715290X6	X3775290X6	X3213290X8	X360290X8
	urban dove	X606291X8	X1556291X8	X373291X8	X370291X8	X975X6291	X670291X8	X3715291X6	X3775291X6	X3213291X8	X360291X8
	urban grey	X606292X8	X1556292X8	X373292X8	X370292X8	X975X6292	X670292X8	X3715292X6	X3775292X6	X3213292X8	X360292X8
	urban sand	X606294X8	X1556294X8	X373294X8	X370294X8	X975X6294	X670294X8	X3715294X6	X3775294X6	X3213294X8	X360294X8
	urban ivory	X606293X8	X1556293X8	X373293X8	X370293X8	X975X6293	X670293X8	X3715293X6	X3775293X6	X3213293X8	X360293X8
	urban white	X606295X8	X1556295X8	X373295X8	X370295X8	X975X6295	X670295X8	X3715295X6	X3775295X6	X3213295X8	X360295X8
pieces - box stück - karton pezzi - scatola pièces - boîte piezas - caja	4	20	11	11	12	10	1	1	4	6	
sqm - box m² - karton m² - scatola m² - boîte m² - caja	1,44	0,45	0,99	0,99	0,81	0,42	0,563	0,281	1,44	1,08	
boxes - pallet karton - palette scatole - pallet boîtes - palette cajas - palé	32	-	-	-	-	-	-	-	-	-	
sqm - pallet m² - palette m² - pallet m² - palette m² - palé	46,08	-	-	-	-	-	-	-	-	-	
weight kg - sqm gewicht kg - m² peso kg - m² poids kg - m² peso kg - m²	17,41	17,41	1,91 (Kg/pcs)	1,57 (Kg/pcs)	0,98 (Kg/pcs)	0,78 (Kg/pcs)	7,91 (Kg/pcs)	3,96 (Kg/pcs)	6,40 (Kg/pcs)	3,12 (Kg/pcs)	
weight kg - box gewicht kg - karton peso kg - scatola poids kg - boîte peso Kg - caja	25,07	7,834	21,01	17,27	11,74	7,80	7,91	3,96	25,60	18,72	

TECHNICAL FEATURES

SQUARED PORCELAIN STONEWARE

TECHNISCHE EIGENSCHAFTEN

KALIBRIERTES FEINSTEINZEUG

CARATTERISTICHE TECNICHE

GRES PORCELLANATO RETTIFICATO

CARACTÉRISTIQUES TECHNIQUES

GRES CÉRAMÉ RECTIFIÉ

CARACTERÍSTICAS TÉCNICAS

GRES PORCELÁNICO RECTIFICADO



products marked with this symbol have been assessed and found to comply with the LEED and BREEAM regulations relating to the minimum recycled content percentage of 40% by weight (of which at least 15% is post-consumer). Certificate is available on request.

die mit diesem Symbol gekennzeichneten Produkte wurden beurteilt und es wurde erklärt, dass sie bezüglich des Mindestprozentsatzes an Recyclingmaterial von 40% des Gewichts (davon mindestens 15% Post-Consumer) den LEED und BREEAM Anforderungen entsprechen. Zertifikat auf Anfrage erhältlich. I i prodotti contrassegnati da questo simbolo sono stati valutati e giudicati conformi ai requisiti LEED e BREEAM in relazione alla percentuale minima di materiale riciclato pari al 40% in peso (di cui almeno 15% post-consumer). Certificato disponibile su richiesta. I les produits accompagnés de ce symbole ont été testés et jugés conformes aux exigences LEED et BREEAM concernant le pourcentage minimal de matériau recyclé (40% du poids dont au moins 15% post-consommation). Certification disponible sur demande. I Los productos marcados con este símbolo han sido validados y adjudicados conforme a los requisitos LEED y BREEAM en relación a los porcentajes mínimos de materiales reciclados iguales al 40% del peso (de ellos, al menos, un 15% post-consumo). Certificado disponible bajo petición.

variability index of the slabs | Variabilitätsindex der Platten | indice di stonizzazione delle lastre | indice de variabilité des dalles | indice de variabilidad de las losas



V1 uniform tone

im Farbton homogen
omogeneo nel tono
ton homogène
tonalidad homogénea



V2 slightly different tone

leicht unregelmäßig im Farbton
leggermente mosso nel tono
ton légèrement nuancé
tono ligeramente variable



V3 different tone

unregelmäßig im Farbton
mosso nel tono
ton nuancé
tonalidad variable



V4 very variable tone

mit starken Unterschieden
tono molto seminato
ton très nuancé
tonalidad muy variable

all Porcelaingres certificates are available upon request and can also be found on our website www.porcelaingres.com | alle Zertifikate von Porcelaingres sind auf Anfrage und auf unserer Website www.porcelaingres.com erhältlich | tutti i certificati di Porcelaingres sono disponibili su richiesta e sul nostro sito internet www.porcelaingres.com | tous les certifications de Porcelaingres sont disponibles sur demande et sur notre site Internet www.porcelaingres.com | de Porcelaingres se pueden obtener mediante solicitud o en nuestro sitio web www.porcelaingres.com

▲ according to the ISO13006 All.G (European Norms) of the B1a category and fully vitrified | nach Normvorgabe ISO13006 All.G (europäische Normen) für Feinsteinzeugfliesen der Klasse B1a | secondo la norma ISO13006 All.G (Norme europee) per piastrelle del gruppo B1a completamente vetrificate | selon la norme ISO13006 All.G (European norme) pour carreaux du groupe B1a et complètement vitrifiés | según la norma ISO 13006 An.G (normas europeas) para baldosas del grupo B1a íntegramente vitrificadas

● average value of production | mittlerer Produktionswert | valore medio di produzione | valeur moyenne de production | valor medio de producción

porcelaingres®
de_tiles

	norms Normen norme norme normas	▲ required standards ▲ Normvorgabe ▲ valore prescritto dalle norme ▲ valeur prescrite par les normes ▲ valor establecido por las normas	URBAN ● porcelaingres
water absorption Wasseraufnahme assorbimento d'acqua absorption d'eau absorción de agua	ISO 10545.3	≤ 0,5%	< 0,05%
sizes Abmessungen dimensioni dimensions dimensiones	ISO 10545.2	length and width Länge und Breite lunghezza e larghezza longueur et largeur longitud y anchura thickness Stärke spessore épaisseur espesor linearity Kanten-Linearität rettilineità spigoli rectitude des arêtes rectitud de los lados wedging Rechtwinklichkeit ortogonalità orthogonalité ortogonalidad warpage Ebenflächigkeit planarità planéité planitud	±0,2% max ±5,0% max ±0,2% max ±0,2% max ±0,2% max
bending strength Biegefestigkeit resistenza alla flessione résistance à la flexion resistencia a la flexión	ISO 10545.4	≥ 35 N/mm ²	> 48N/mm ²
resistance to deep abrasion Widerstand gegen Tiefenverschleiß resistenza all'abrasione profonda résistance à l'abrasion profonde resistencia a la abrasión profunda	ISO 10545.6	≤ 175 N/mm ³	140 mm ³
thermal expansion coefficient Wärmeausdehnungskoeffizient coefficiente di dilatazione termica lineare coefficient de dilatation thermique linéaire coeficiente de dilatación térmica lineal	ISO 10545.8	testing method available verfügbares Prüfverfahren metodo di prova disponibile méthode d'essai disponible método de ensayo disponible	7 MK ⁻¹
thermal shock resistance Temperaturwechselbeständigkeit resistenza agli sbalzi termici résistance aux écarts de température resistencia al choque térmico	ISO 10545.9	testing method available verfügbares Prüfverfahren metodo di prova disponibile méthode d'essai disponible método de ensayo disponible	resistant widerstandsfähig resistenti résistants resistentes
frost resistance Frostbeständigkeit resistenza al gelo résistance au gel resistencia a la helada	ISO 10545.12	no sample must show alterations to surface die Muster sollen weder Bruch noch Schäden an der Oberfläche aufweisen nessun campione deve presentare rotture o alterazioni apprezzabili della superficie aucun échantillon ne doit présenter de ruptures ou d'altérations considérables de la surface las muestras no deben presentar roturas o alteraciones apreciables de la superficie	frost resistance frostbeständig non gelivi non gélifs resistentes a la helada
chemical resistance Beständigkeit gegen Chemikalien resistenza all'attacco chimico résistance à l'attaque chimique resistencia a la agresión química	ISO 10545.13	UB min. UB min UB min UB min UB min	unaffected nicht angegriffen conforme non attaqués resistentes a los agentes químicos
stain resistance Fleckenbeständigkeit resistenza alle macchie résistantes aux taches resistencia a las manchas	ISO 10545.14	unglazed tiles: testing method available unglasierte Fliesen: verfügbares Prüfverfahren piastrelle non smaltate: metodo di prova disponibile arreaux non-émaillés: méthode d'essai disponible baldosas no esmaltadas: método de ensayo disponible	class 5 Klasse 5 classe 5 clase 5 classe 5
colour resistance to light Lichtbeständigkeit resistenza dei colori alla luce résistance des couleurs à la lumière resistencia de los colores a la luz	DIN 51094	no sample must show noticeable colour change kein Exemplar soll sichtbare Farbveränderungen aufweisen nessun campione deve presentare apprezzabili variazioni di colore arreaux non-émaillés: méthode d'essai disponible ninguna muestra debe presentar variaciones de color apreciables	no change in brightness or colour Glanz und Farbe der Muster unverändert campioni inalterati in brillantezza e colore échantillons inchangés en brillance et couleur muestras con brillo y color inalterado
brightness (polished) Glanz (geschliffen) brillantezza (levigati) brillant (polis) brillantez (pulidos)			
skid resistance average coefficient on friction (μ) Rutschhemmende Eigenschaft mittlerer Reibungswert (μ) scivolosità coefficiente di attrito medio (μ) nature glissante coefficient de frottement moyen (μ) antideslizante coeficiente de fricción media (μ)	DIN 51130 DIN 51097		R10 — natural natur naturale naturel natural - 6 - 8 mm R11 — natural natur naturale naturel natural - 6 - 20 mm A+B — natural natur naturale naturel natural - 6 - 8 mm A+B — natural natur naturale naturel natural - 6 - 20 mm



Porcelaingres GmbH

Irisstraße 1
03226 Vetschau – Deutschland
Tel +49 (0)35433 / 597-0
Fax +49 (0)35433 / 597-170

Porcelaingres Italia

Via Radici Nord 112
42014 Castellarano (RE) - Italy
Tel +39 0536 819611
Fax +39 0536 858082
Fax +39 0536 850088

Berlin Showroom

Mehringdamm 55
10691 Berlin - Deutschland
Tel +49 (0)30 / 616753017

Castellarano Showroom

Via Guido Reni 2
42014 Castellarano (RE) - Italy
Tel +39 0536 / 855557

www.porcelaingres.com
info@porcelaingres.com



Search "PORCELAINGRES" on your app store
www.porcelaingres.com/pdfapp

Colors and decors reproductions are approximate. All rights are reserved. Total or partial reproduction of text or illustrations of this catalogue is prohibited and is subject to legal sanctions. The tables with the data referred to the content per box and to the packing weight are update at the catalogue printing time; therefore the listed data can be altered.

Farbdruckwiedergabe und Dekore Unverbindlich. Alle Rechte sind vorbehalten. Der vollständige oder auszugsweise Nachdruck des Inhalts dieses Kataloges in Schrift und Bild ist verboten und wird nach Maßgabe des Gesetzes geahndet. Die in den Tabellen enthaltenen Daten in Bezug auf den Inhalt pro Karton und das Gewicht der jeweiligen Verpackung sind zum Ausgabedatum richtiggestellt worden. Jeweilige Veränderungen entsprechender Daten sind somit vorbehalten.

La riproduzione di colori e decori è approssimativa. Tutti i diritti sono riservati. Ogni riproduzione totale o parziale dei contenuti del presente catalogo, sia di testo che di immagine, è vietata e sarà perseguita in termini di legge. Le tabelle con i dati riferiti ai contenuti per scatole ed ai pesi degli imballi sono aggiornate al momento della stampa del catalogo, pertanto i dati elencati possono subire variazioni.

Reproduction de couleurs and décorations sont approximative. Tous les droits sont réservés. Toute reproductions totale ou partielle du contenu - textes et images - du présent catalogue est interdite et constituerait une contrefaçon sanctionnée par la loi. Les tables avec les données concernant les contenus par colis et les poids des emballage sont ajournés au moment où le catalogue est imprimé, c'est pourquoi les données peuvent subir des variations.

La reproducción de los colores y las decoraciones es indicativa. Todos los derechos están reservados. La reproducción total o parcial de los contenidos del presente catálogo, textos o imágenes, está prohibida y será perseguida con arreglo a la ley. Las tablas con los datos relativos a los contenidos para cajas y a los pesos de los embalajes corresponden al momento en el que se imprime el catálogo, por lo que los datos indicados pueden sufrir variaciones.

